

# CATÁLOGO SEÑALIZACIÓN



## SEÑALES

ANTES DE ELEGIR SU SEÑAL.....	02
OBLIGACIÓN .....	04
PROHIBICIÓN.....	17
ADVERTENCIA.....	32
SEÑALES COMBINADAS.....	50
SOCORRO - PVC FOTOLUMINISCENTE CLASE B.....	53
EVACUACIÓN - PVC FOTOLUMINISCENTE CLASE B.....	58
EVACUACIÓN - PVC FOTOLUMINISCENTE CLASE A.....	63
SOCORRO - PVC FOTOLUMINISCENTE CLASE A.....	65
PLANOS DE EVACUACIÓN.....	66
SEÑALES NUEVAS / CTE / NUEVA NORMATIVA .....	67
SEÑALES EN CATALÁN .....	68
SEÑALES EN ALUMINIO .....	71
RECICLAJE Y ESPECIAL LEY ANTITABACO .....	73
ACCESORIAS .....	74
INFORMATIVAS.....	76
PLACAS VARIAS .....	78
ESPECIALES .....	79
MATERIAS PELIGROSAS .....	80
RADIACIÓN.....	82
ETIQUETAS DE SEÑALIZACIÓN .....	83
SEÑALIZACIÓN PARA OBRAS.....	84
CINTAS DE BALIZAMIENTO.....	86
MARÍTIMAS .....	87
PERSONALIZADAS.....	90
SEÑALIZACIÓN GRANDES DIMENSIONES .....	91
SEÑALIZACIÓN PARA SUELO .....	92
MARCOS PARA SEÑALES .....	94

## PRODUCTOS

POSTES .....	96
CONOS.....	105
CABALLETES .....	107
VALLAS .....	110
ACCESORIOS DE OBRA.....	112
ESPEJOS .....	114
REDUCTORES.....	116
PROTECTORES DE CABLE / MANGUERA .....	117
TOPE / CALZOS.....	118
TOPE, BLOQUEOS Y ESQUINEROS .....	119
PROTECTORES DE ESPUMA PU .....	120
PROTECCIÓN ALMACENAJE .....	121
DISPLAYS .....	122
URNAS .....	123
PIZARRAS .....	124
VITRINAS.....	126
ACCESORIOS DE SEÑALIZACIÓN.....	128
DIRECTORIOS .....	142
SISTEMAS DE SEÑALIZACIÓN .....	143
SEPARADORES-EMBELLECEDORES .....	149
DISPENSADOR DE BOLSAS PARA PARAGUAS.....	152
APARCA BICICLETAS .....	154

## EPIS

EQUIPOS DE PROTECCIÓN INDIVIDUAL.....	155
---------------------------------------	-----

## NORMATIVA

La aplicación de colores en las Señales de Seguridad tiene como misión llamar rápidamente la atención sobre un peligro. Deben ser utilizadas para indicar el emplazamiento de dispositivos y equipos que tengan importancia desde el punto de vista de la Seguridad, no eliminando el peligro por sí misma, ni pudiendo la información que facilita sustituir a las Normas de Seguridad que se hayan adoptado.

Todos los pictogramas, colores, tamaños y formas geométricas que forman parte de las señales de este catálogo, cumplirán con el Real Decreto 2177/1996, de 4 de octubre, que aprueba la norma básica de la edificación

«N.B.E.-CPI-96» (art. 12 apartados 1 y 2) con las siguientes normas:

- UNE 81-501-81 (Señalización de Seguridad en los lugares de Trabajo).
- UNE 23-033-81 (Seguridad contra Incendios, Señalización).
- UNE 1-089-81 (Símbolos gráficos).
- UNE 72-036-82 (Especificación de diferencias de color psicofísicas).
- UNE 1-115-85 (Colores y Señales de Seguridad).
- UNE 23-034-88 (Seguridad contra Incendios. Señalización de Seguridad, Vías de Evacuación).
- UNE 1-089-90 (Principios generales para la creación de Símbolos Gráficos).
- UNE 1-011-90 (Medidas).
- UNE 23-035- 1 (Seguridad contra Incendios. Señalización fotoluminiscente)
  - Parte 1: Medida y Calificación.
  - Parte 2: Medida y productos en el lugar de utilización.
  - Parte 3: Señalización y fotoluminiscentes balizantes.
  - Parte 4: Condiciones generales, mediciones y clasificación.
- Real Decreto 192/1988 de 4 de marzo de 1998 (artículo 7°).

## PRINCIPALES TIPOS DE SEÑALES

### OBLIGACIÓN

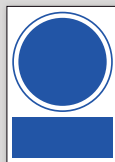

Este conjunto de señales obligan a una conducta determinada. Su forma debe ser redonda con el pictograma blanco sobre fondo de color azul.

### PROHIBICIÓN



Prohíben de una conducta susceptible de provocar un peligro. Tienen forma redonda con pictograma negro sobre fondo blanco y con contorno más banda transversal rojos.

### ADVERTENCIA



Estas señales advierten de un riesgo o peligro. Su forma debe ser triangular con el pictograma negro sobre fondo amarillo y contorno negro.

### SOCORRO

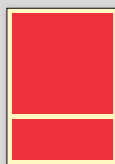

Estas señales sirven para indicar la ubicación de los equipos de lucha y ayuda contra incendios. Su pictograma debe ser blanco sobre fondo rojo.

### EVACUACIÓN

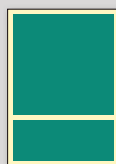

Estas señales proporcionan indicaciones relativas a salidas de evacuación, de primeros auxilios o a dispositivos de salvamento. Su pictograma es blanco sobre fondo verde.



### INFORMATIVAS



Este grupo de señales ayudan a la orientación espacial dentro de los edificios. Formato rectangular, pictograma blanco sobre fondo azul.

## DISTANCIAS MÁXIMAS DE OBSERVACIÓN (DMO)

Distancias máximas de observación, según las dimensiones y forma de la señal.

DMO según forma			
Dimensiones			
420 mm	12.36 metros	17.57 metros	18.78 metros
297 mm	8.74 metros	12.42 metros	13.28 metros
210 mm	6.18 metros	8.78 metros	9.39 metros
148 mm	4.36 metros	6.19 metros	6.62 metros
105 mm	3.09 metros	4.39 metros	4.70 metros

## MATERIALES PARA SEÑALIZACIÓN

### CÓDIGO (P)

#### **Poliestireno de 1.5mm**



Las señales serigrafiadas en este material se caracterizan por ser rígidas, ligeras y con alta resistencia a los impactos. Producida con un grosor estándar de 1.5mm, permiten multitud de sistemas de fijación como silicona, adhesivo de doble cara o mediante tornillería, etc...

### CÓDIGO (AF)

#### **Vinilo adhesivo fotoluminiscente**



Las señales fotoluminiscentes de vinilo son una solución económica para mejorar la seguridad en el lugar de trabajo. En caso de una deficiente iluminación, provocada por un corte de corriente o por un incendio, estas señales brillan lo suficiente para ser vistas en la oscuridad.

### CÓDIGO (A)

#### **Vinilo adhesivo**



Es un material ligero, flexible y con una alta adherencia, ideal para su uso en oficinas, industrias o almacenes. Para una buena fijación de la señal, el vinilo se debe aplicar sobre una superficie lisa, que debe encontrarse limpia y seca en el momento de su aplicación.

### CÓDIGO (AL)

#### **Aluminio lacado en blanco**



La combinación del aluminio con el lacado nos aporta una buena rigidez y una gran resistencia al paso del tiempo.

### CÓDIGO (AO)

#### **Aluminio oro**

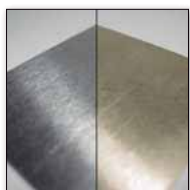

El acabado dorado o plateado de este material, le confiere una terminación de alta calidad y le permite integrarse a la perfección en cualquier ambiente de decoración. Además al producirse impresa en serigrafía conseguimos una gran durabilidad.

### CÓDIGO (AP)

#### **Aluminio plata**

### CÓDIGO (F)

#### **PVC fotoluminiscente Clase A**



Señal de PVC rígido fotoluminiscente "Clase A" de 1.4mm de grosor. Es ideal para la identificación inmediata de rutas de evacuación y equipos de protección contra incendios. Para sitios de concurrencia pública y/o luz artificial.

### CÓDIGO (L)

#### **PVC fotoluminiscente Clase B**



Señal de PVC rígido fotoluminiscente "Clase B" de 1.4mm de grosor. Para sitios privados o iluminados con luz natural.

## ESPECIFICACIONES SOBRE FOTOLUMINISCENCIA

### CARACTERÍSTICAS CLASE A

Colocación en sitios de concurrencia pública y/o luz artificial.

NORMATIVAS	LUMINANCIA A LOS 10 MIN.	LUMINANCIA A LOS 60 MIN.	TIEMPO DE ATENUACIÓN
NORMATIVA UNE 23035-4:2003	210 mcd/m <sup>2</sup>	29 mcd/m <sup>2</sup>	3.000 minutos
PVC 1.4mm fotoluminiscente	392 mcd/m <sup>2</sup>	52.4 mcd/m <sup>2</sup>	5.946 minutos

### CARACTERÍSTICAS CLASE B

Resto de ubicaciones.

NORMATIVAS	LUMINANCIA A LOS 10 MIN.	LUMINANCIA A LOS 60 MIN.	TIEMPO DE ATENUACIÓN
NORMATIVA UNE 23035-4:2003	40 mcd/m <sup>2</sup>	5,6 mcd/m <sup>2</sup>	800 minutos
PVC 1.4mm fotoluminiscente	106.4 mcd/m <sup>2</sup>	14.90 mcd/m <sup>2</sup>	2.093 minutos



## OBLIGACIÓN

### Formato DIN | Pictograma y texto

Este tipo de señales obligan a un comportamiento determinado. Su pictograma debe ser redondo en color blanco y el fondo azul. Disponible en poliestireno de 1.5mm o vinilo adhesivo.

#### Importante al hacer su pedido

1. Elija la señal que desee y anote la referencia y el formato.
2. Añada el código de tamaño de entre las medidas disponibles para este formato.
3. Por último, añada el código correspondiente al material.

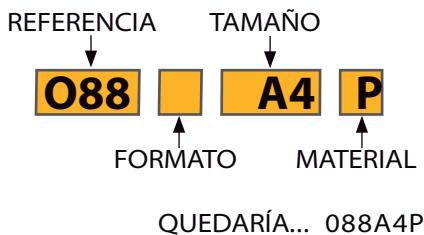

### Medidas y materiales

MATERIAL	MEDIDA	Din A3 297x420mm	Din A4 210x297mm	Din A5 148x210mm	Din A6 105x148mm	60x80mm
Poliestireno 1.5mm (P)		___A3P	___A4P	___A5P	___A6P	
Vinilo adhesivo (A)			___A4A	___A5A	___A6A	___80A





O46



O72



O11



O12



O13



O49



O16



O57



O37



O65



O75



O76



O60



O56



O32



O48



O73



O62



O80



O14



O71



O90



O15



O17



O91



O18



O19



O35



O58



O20



O21



O22



O53



O29



O30



O59





O92



O25



O66



O26



O27



O23



O24



O33



O34



O31



O84



O83



O81



O28



O50



O38



O54



O39



O40



O61





063



036



067



077



078



051



052



096



069



070



074



055



082



085



086



087



088



089



093



094



095



068



## OBLIGACIÓN

### C | Cuadrada | Sólo pictograma

Este tipo de señales obligan a un comportamiento determinado. Su pictograma debe ser redondo en color blanco y fondo azul. Disponible en poliestireno de 1.5mm o vinilo adhesivo.

#### Importante al hacer su pedido

1. Elija la señal que desee y anote la referencia y el formato.
2. Añada el código de tamaño de entre las medidas disponibles para este formato.
3. Por último, añada el código correspondiente al material.

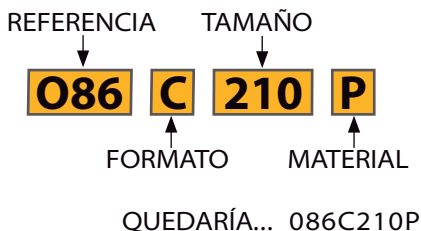

#### Medidas y materiales

MATERIAL \ MEDIDA	297x297mm	210x210mm	148x148mm	105x105mm	60x60mm
Poliestireno 1.5mm (P)	___297P	___210P	___148P	___105P	
Vinilo adhesivo (A)		___210A	___148A	___105A	___60A

O01C	O02C	O03C	O04C	O042C	O05C
O06C	O07C	O041C	O043C	O044C	O045C
O08C	O047C	O09C	O10C	O072C	O11C
O12C	O13C	O16C	O057C	O037C	O065C





O76C



O60C



O56C



O48C



O73C



O62C



O49C



O79C



O80C



O14C



O90C



O15C



O17C



O91C



O18C



O19C



O35C



O58C



O20C



O21C



O22C



O53C



O29C



O59C



O25C



O26C



O27C



O23C



O24C



O33C



O34C



O31C





O84C



O83C



O81C



O32C



O28C



O50C



O38C



O54C



O39C



O40C



O61C



O63C



O36C



O67C



O77C



O78C



O51C



O52C



O96C



O68C



O69C



O82C



O85C



O86C



O93C



O94C



O95C



O70C



O74C



O55C



O87C



O88C



O89C





## OBLIGACIÓN

### R | Rectangular | Pictograma y texto

Este tipo de señales obligan a un comportamiento determinado. Su pictograma debe ser redondo en color blanco y fondo azul. Disponible en poliestireno de 1.5mm.

#### Importante al hacer su pedido

1. Elija la señal que desee y anote la referencia y el formato.
2. Añada el código de tamaño de entre las medidas disponibles para este formato.
3. Por último, añada el código correspondiente al material.

REFERENCIA      TAMAÑO  
**053**   **R**   **717**   **P**  
 FORMATO      MATERIAL  
 QUEDARÍA... 053R717P



#### Medidas y materiales

MATERIAL	MEDIDA	717x297mm	507x210mm
Poliestireno 1.5mm (P)		___717P	___507P





O12R



O13R



O16R



O57R



O37R



O65R



O75R



O76R



O60R



O56R



O48R



O73R



O62R



O49R



O79R



O80R



O14R



O71R



O90R



O15R



O17R



O91R



O18R



O19R



O35R



O58R



O20R



O21R



O22R



O53R



O29R



O30R



O59R



O92R



O25R



O66R



O26R



O27R



O23R



O24R





**ES OBLIGATORIO  
ELIMINAR  
LAS PUNTAS**

O33R



**OBLIGATORIO  
REVISAR  
CABLES Y CADENAS**

O34R



**APAGAR  
CUANDO  
NO SE USE**

O31R



**DESCONECTAR  
ANTES DE  
MANTENER  
O REPARAR**

O84R



**OBLIGATORIO  
CONECTAR  
A TIERRA**

O83R



**DESCONECTAR EL  
ENCHUFE DE LA  
CORRIENTE**

O81R



**EQUIPO DE  
SOLDADURA**

O32R



**ES OBLIGATORIO  
LAVARSE LAS MANOS**

O28R



**OBLIGATORIO  
DUCHARSE**

O50R



**AGUA  
POTABLE**

O38R



**UTILICEN LA  
PAPELERA**

O54R



**ABROCHARSE  
CINTURÓN  
DE SEGURIDAD**

O39R



**USO  
OBLIGATORIO  
DE LUCES**

O40R



**NO COLOCARSE  
ENCIMA DE  
LA CARGA**

O61R



**PASO  
OBLIGATORIO  
DE CARRETILLAS**

O63R



**CUIDE SU  
ESPALDA**

O36R



**UTILIZAR LAS  
RODILLAS PARA  
LEVANTAR PESO**

O67R



**USO OBLIGATORIO  
DE FAJA LUMBAR**

O77R



**OBLIGATORIO MANIPULAR  
LA MERCANCIA  
DE FORMA CORRECTA**

O78R



**OBLIGATORIO EL  
USO DE BOZAL**

O51R



**OBLIGATORIO  
LLEVAR LOS  
PERROS SUJETOS**

O52R



**ES OBLIGATORIO  
RECOGER LOS  
EXCREMENTOS**

O96R



**ARO  
SALVAVIDAS**

O68R



**OBLIGATORIO  
MANTENER  
ORDEN Y LIMPIEZA**

O69R



**OBLIGATORIO  
AVISAR ANTES DE  
SU FUNCIONAMIENTO**

O70R



**OBLIGATORIO  
CALZAR EL VEHICULO**

O74R



**UTILIZAR EL  
PASAMANOS**

O55R



**UTILIZAR EL  
PASAMANOS**

O82R



**OBLIGATORIO  
TOCAR  
LA BOCINA**

O85R



**OBLIGATORIO  
CERRAR LA BARRA  
DE SEGURIDAD  
DEL TELESILLA**

O86R



**OBLIGATORIO  
ABRIR LA BARRA  
DE SEGURIDAD  
DEL TELESILLA**

O87R



**LEVANTAR  
LAS PUNTAS DE  
LOS ESQUÍ**

O88R



**ABANDONAR  
INMEDIATAMENTE EL  
REMOLQUE DE PISTA  
EN CASO DE CAIDA**

O89R



**ES OBLIGATORIO  
LEER EL MANUAL  
DE INSTRUCCIONES**

O93R



**ES OBLIGATORIO  
LEER EL MANUAL  
DE INSTRUCCIONES**

O94R



**LEA EL  
MANUAL DE  
MANTENIMIENTO**

O95R



## OBLIGACIÓN

### T | Texto apaisado | Sólo texto

Este tipo de señales obligan a un comportamiento determinado. De forma rectangular con el texto blanco y el fondo en azul. Disponible en poliestireno de 1.5mm.

#### Importante al hacer su pedido

1. Elija la señal que desee y anote la referencia y el formato.
2. Añada el código de tamaño de entre las medidas disponibles para este formato.
3. Por último, añada el código correspondiente al material.



#### Medidas y materiales

MATERIAL	MEDIDA	DIN A3 420x297mm	DIN A4 297x210mm
Poliestireno 1.5mm (P)		___A3P	___A4P



O01T



O02T



O064T



O03T



O04T



O042T



O05T



O06T



O07T



O041T



O043T



O044T



O045T



O08T



O047T



O09T



O010T



O046T



O072T



O011T

USO OBLIGATORIO  
DE BOTAS  
DIELECTRICAS

O12T

USO OBLIGATORIO  
DE CALZADO  
ANTIESTÁTICO

O13T

USO OBLIGATORIO  
DE ROPA  
PROTECTORA

O16T

USO OBLIGATORIO  
DE ROPA AJUSTADA

O65T

USO OBLIGATORIO  
DE CHAQUETA  
IGNIFUGA

O75T

USO  
OBLIGATORIO  
DE UNIFORME

O76T

USO OBLIGATORIO  
DE BATA

O60T

USO OBLIGATORIO  
DE DELANTAL Y  
MANGUITOS EN  
PRODUCTOS QUÍMICOS

O56T

USO OBLIGATORIO  
DE MANDIL

O48T

USO OBLIGATORIO  
DE MANDIL METÁLICO  
CUANDO  
SE DESHUESE

O73T

USO OBLIGATORIO  
DE CHALECO  
REFLECTANTE

O62T

USO OBLIGATORIO  
DE CUBREPIÉS

O49T

USO OBLIGATORIO  
DE GORRA  
PROTECTORA

O79T

USO OBLIGATORIO  
DE PULSERA  
IDENTIFICATIVA

O80T

USO OBLIGATORIO  
DE CINTURÓN  
DE SEGURIDAD

O14T

USO OBLIGATORIO  
DE ARNÉS  
DE SEGURIDAD

O71T

USO OBLIGATORIO  
DEL CABO DE  
DOBLE ANCLAJE

O90T

USO OBLIGATORIO  
DE CINTURÓN  
ANTIVIBRATORIO

O15T

USO OBLIGATORIO  
DE EQUIPO AUTÓNOMO

O17T

USO OBLIGATORIO  
DE EQUIPO  
SEMIATÓNOMO

O91T

USO OBLIGATORIO  
DE PROTECTOR FIJO

O18T

USO OBLIGATORIO  
DE PROTECTOR  
AJUSTABLE

O19T

ES OBLIGATORIO  
EL USO DE  
PROTECTOR DE MOLA

O35T

ES OBLIGATORIO  
ENGANCHAR  
LAS BOTELLAS

O58T

OBLIGATORIO APILAR  
CORRECTAMENTE

O20T

NO OBSTRUIR  
LA PUERTA

O21T

ES OBLIGATORIO  
CERRAR LAS PUERTAS

O22T

ES OBLIGATORIO  
MANTENER CERRADO

O53T

DIRECCIÓN  
OBLIGATORIA  
→

O29T

DIRECCIÓN  
OBLIGATORIA  
←

O30T

OBLIGACIÓN  
GENERAL

O59T

USO OBLIGATORIO  
DE EPIS

O92T

PASO OBLIGATORIO  
PARA PERSONAS

O25T

SÓLO  
PERSONAL  
AUTORIZADO

O66T

OBLIGATORIO  
APAGAR EL  
CIGARRILLO

O26T

PERMITIDO  
FUMAR

O27T

SÓLO  
MERCANCIAS

O23T

SÓLO  
PERSONAS

O24T

ES OBLIGATORIO  
ELIMINAR  
LAS PUNTAS

O33T

OBLIGATORIO  
REVISAR  
CABLES Y CADENAS

O34T



**APAGAR  
CUANDO  
NO SE USE**

O31T

**DESCONECTAR  
ANTES DE  
MANTENER  
O REPARAR**

O84T

**OBLIGATORIO  
CONECTAR  
A TIERRA**

O83T

**DESCONECTAR EL  
ENCHUFE DE LA  
CORRIENTE**

O81T

**EQUIPO DE  
SOLDADURA**

O32T

**ES OBLIGATORIO  
LAVARSE LAS MANOS**

O28T

**OBLIGATORIO  
DUCHARSE**

O50T

**AGUA  
POTABLE**

O38T

**UTILICEN LA  
PAPELERA**

O54T

**ABROCHARSE  
CINTURÓN  
DE SEGURIDAD**

O39T

**USO  
OBLIGATORIO  
DE LUCES**

O40T

**NO COLOCARSE  
ENCIMA DE  
LA CARGA**

O61T

**PASO  
OBLIGATORIO  
DE CARRETILLAS**

O63T

**CUIDE SU  
ESPALDA**

O36T

**UTILIZAR LAS  
RODILLAS PARA  
LEVANTAR PESO**

O67T

**USO  
OBLIGATORIO  
DE FAJA LUMBAR**

O77T

**OBLIGATORIO MANIPULAR  
LA MERCANCIA  
DE FORMA CORRECTA**

O78T

**OBLIGATORIO EL  
USO DE BOZAL**

O51T

**OBLIGATORIO  
LLEVAR LOS  
PERROS SUJETOS**

O52T

**ES OBLIGATORIO  
RECOGER LOS  
EXCREMENTOS**

O96T

**ARO  
SALVAVIDAS**

O68T

**OBLIGATORIO  
MANTENER  
ORDEN Y LIMPIEZA**

O69T

**OBLIGATORIO  
AVISAR ANTES DE  
SU FUNCIONAMIENTO**

O70T

**OBLIGATORIO  
CALZAR  
EL VEHÍCULO**

O74T

**UTILIZAR EL  
PASAMANOS**

O55T

**OBLIGATORIO  
TOCAR  
LA BOCINA**

O85T

**OBLIGATORIO  
CERRAR LA BARRA  
DE SEGURIDAD  
DEL TELESILLA**

O86T

**OBLIGATORIO  
ABRIR LA BARRA  
DE SEGURIDAD  
DEL TELESILLA**

O87T

**LEVANTAR  
LAS PUNTAS DE  
LOS ESQUÍ**

O88T

**ABANDONAR  
INMEDIATAMENTE EL  
REMOLQUE DE PISTA  
EN CASO DE CAIDA**

O89T

**ES OBLIGATORIO  
LEER EL MANUAL  
DE INSTRUCCIONES**

O93T

**LEA EL  
MANUAL DE  
MANTENIMIENTO**

O94T

**ES OBLIGATORIO  
RECOGER LOS  
EXCREMENTOS**

O95T

## PROHIBICIÓN

### Formato DIN | Pictograma y texto

Este tipo de señales prohíben un determinado comportamiento. Su pictograma es circular de color rojo con silueta en negro sobre fondo blanco y los bordes y la banda transversal en color rojo.

Disponible en poliestireno de 1.5mm o vinilo adhesivo.

#### Importante al hacer su pedido

1. Elija la señal que desee y anote la referencia y el formato.
2. Añada el código de tamaño de entre las medidas disponibles para este formato.
3. Por último, añada el código correspondiente al material.

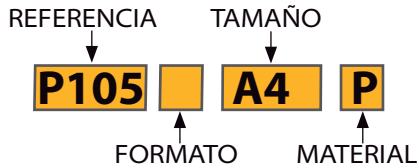

### Medidas y materiales

MATERIAL \ MEDIDA	Din A3 297x420mm	Din A4 210x297mm	Din A5 148x210mm	Din A6 105x148mm	60x80mm
Poliestireno 1.5mm (P)	___A3P	___A4P	___A5P	___A6P	
Vinilo adhesivo (A)		___A4A	___A5A	___A6A	___80A







P06



P07



P08



P10



P99



P11



P88



P14



P15



P32



P34



P69



P33



P79



P35



P92



P38



P85



P95



P56



P59



P65



P70



P58



P90



P49



P68



P71





P101



P17



P40



P18



P96



P97



P81



P19



P21



P22



P46



P47



P54



P23



P24



P45



P29



P30



P75



P74



P31



P80



P36



P89



P12



P73



P84



P87



P13



P106



P39



P44



P77



P78



P103



P72





P16



P83



P37



P86



P67



P93



P94



P108



P98



P91



P09



P66



P57



P104



P20



P102



P25



P26



P100



P62



P61



P27



P109



P110



P28



P60



P64





## PROHIBICIÓN

### C | Cuadrada | Sólo pictograma

Este tipo de señales prohíben un determinado comportamiento. Su pictograma es circular de color rojo con silueta en negro sobre fondo blanco y los bordes y la banda transversal en color rojo.

Disponible en poliestireno de 1.5mm o vinilo adhesivo.

#### Importante al hacer su pedido

1. Elija la señal que desee y anote la referencia y el formato.
2. Añada el código de tamaño de entre las medidas disponibles para este formato.
3. Por último, añada el código correspondiente al material.



#### Medidas y materiales

MATERIAL \ MEDIDA	297x297mm	210x210mm	148x148mm	105x105mm	60x60mm
Poliestireno 1.5mm (P)	___297P	___210P	___148P	___105P	
Vinilo adhesivo (A)		___210A	___148A	___105A	___60A

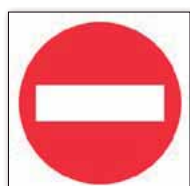

P01C



P02C



P76C



P03C



P105C



P82C



P06C



P07C



P08C



P10C



P99C



P11C



P88C



P14C



P15C



P32C



P34C



P35C



P92C



P38C



P85C



P95C



P69C



P56C



P59C



P65C



P70C



P33C



P79C



P58C



P90C



P49C



P68C



P71C



P101C



P17C



P18C



P96C



P97C



P81C



P19C



P21C



P23C



P24C



P29C



P74C



P31C



P80C

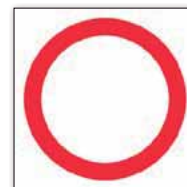

P36C



P12C



P73C



P84C



P87C



P13C



P106C



P39C





P44C



P77C



P78C



P103C



P72C



P16C



P83C



P37C



P86C



P67C



P93C



P94C



P108C



P98C



P91C



P09C



P66C



P57C



P104C



P20C



P102C



P25C



P26C



P100C



P62C



P61C



P109C



P110C



P28C



P60C



P64C



P27C





## PROHIBICIÓN

### R | Rectangular | Pictograma y texto

Este tipo de señales prohíben un determinado comportamiento. Su pictograma es circular de color rojo con silueta en negro sobre fondo blanco y los bordes y la banda transversal en color rojo. Disponible en poliestireno de 1.5mm.

#### Importante al hacer su pedido

1. Elija la señal que desee y anote la referencia y el formato.
2. Añada el código de tamaño de entre las medidas disponibles para este formato.
3. Por último, añada el código correspondiente al material.



#### Medidas y materiales

MATERIAL	MEDIDA	717x297mm	507x210mm
Poliestireno 1.5mm (P)		___717P	___507P



P01R



P02R



P42R



P43R



P48R



P55R



P63R



P76R



P03R



P04R



P41R



P05R



P50R



P51R



P52R



P53R



P105R



P82R



P06R



P07R



P08R



P10R



P99R



P11R



P88R



P14R



P15R



P32R



P34R



P35R



P92R



P38R



P85R



P95R



P69R



P56R



P59R



P65R



P70R



P33R



P79R



P58R



P90R



P49R



P68R



P71R



P101R



P17R



P40R



P18R



P96R



P97R



P81R



P19R



P21R



P22R



P46R



P47R



P54R



P23R





P24R



P45R



P29R



P30R



P75R



P74R



P31R



P80R



P36R



P89R



P12R



P73R



P84R



P87R



P13R



P106R



P39R



P44R



P77R



P78R



P103R



P72R



P16R



P83R



P37R



P86R



P67R



P93R



P94R



P108R





P98R



P91R



P09R



P66R



P57R



P104R



P20R



P102R



P25R



P26R



P100R



P62R



P61R



P28R



P60R



P64R



P27R



P109R



P110R





## PROHIBICIÓN

### T | Texto apaisado | Sólo texto

Este tipo de señales prohíben un determinado comportamiento. De forma rectangular con el texto en blanco sobre fondo rojo. Disponible en poliestireno de 1.5mm.

#### Importante al hacer su pedido

1. Elija la señal que desee y anote la referencia y el formato.
2. Añada el código de tamaño de entre las medidas disponibles para este formato.
3. Por último, añada el código correspondiente al material.



#### Medidas y materiales

MATERIAL	MEDIDA	DIN A3 420x297mm	DIN A4 297x210mm
Poliestireno 1.5mm (P)		___ A3P	___ A4P



P01T



P02T



P42T



P43T



P48T



P55T



P63T



P76T



P03T



P04T



P41T



P05T



P50T



P51T



P52T



P53T



P105T



P82T



P06T



P07T



P08T



P99T



P11T



P88T



P14T



P15T



P32T



P34T



P35T



P92T



P38T



P85T



P95T



P69T



P56T



P59T



P65T



P70T



P33T



P79T



P58T



P90T



P49T



P68T



P71T



P17T



P40T



P18T



P96T



P97T



P81T



P19T



P21T



P22T



P46T



P47T



P54T



P23T



P24T



P45T





P29T



P30T



P75T



P74T



P80T



P36T



P89T



P12T



P73T



P84T



P87T



P13T



P77T



P78T



P103T



P72T



P16T



P83T



P37T



P86T



P67T



P93T



P94T



P108T



P98T



P91T



P09T



P66T



P57T



P104T



P20T





P102T



P25T



P26T



P100T



P62T



P61T



P28T



P60T



P64T



P27T



P107T



P109T



P110T





## ADVERTENCIA

### Formato DIN | Pictograma y texto

Este tipo de señales advierten de un riesgo y/o peligro. Su pictograma tiene forma triangular con borde y silueta en negro sobre fondo amarillo.  
 Texto aclaratorio en negro sobre fondo amarillo.  
 Disponible en poliestireno de 1.5mm o vinilo adhesivo.

#### Importante al hacer su pedido

1. Elija la señal que desee y anote la referencia y el formato.
2. Añada el código de tamaño de entre las medidas disponibles para este formato.
3. Por último, añada el código correspondiente al material.



### Medidas y materiales

MATERIAL \ MEDIDA	Din A3 297x420mm	Din A4 210x297mm	Din A5 148x210mm	Din A6 105x148mm	60x80mm
Poliestireno 1.5mm (P)	___A3P	___A4P	___A5P	___A6P	
Vinilo adhesivo (A)		___A4A	___A5A	___A6A	___80A

A01	A110	A111	A87	A71	A02
A03	A58	A41	A45	A62	A04
A51	A05	A44	A61	A40	A47



A07



A43



A96



A10



A08



A38



A57



A06



A66



A82



A09



A30



A49



A12



A11



A31



A32



A93



A13



A50



A35



A34



A85



A102



A42



A21



A99



A37



A92



A91



A211



A68



A76



A25



A79



A251





A39



A26



A27



A67



A88



A89



A16



A69



A90



A14



A94



A95



A70



A28



A33



A65



A86



A22



A24



A56



A23



A83



A77



A78



A81



A73



A74



A75



A98



A55



A80



A19



A17



A18



A20



A72



A29



A63



A64



A46



A36



A48



A52



A53



A54



A97



A84



A15



A100





## ADVERTENCIA

### C | Cuadrada | Sólo pictograma

Este tipo de señales advierten de un riesgo y/o peligro. Su pictograma tiene forma triangular con borde y silueta en negro sobre fondo amarillo. Disponible en poliestireno de 1.5mm o vinilo adhesivo.

#### Importante al hacer su pedido

1. Elija la señal que desee y anote la referencia y el formato.
2. Añada el código de tamaño de entre las medidas disponibles para este formato.
3. Por último, añada el código correspondiente al material.



#### Medidas y materiales

MATERIAL \ MEDIDA	297x297mm	210x210mm	148x148mm	105x105mm	60x60mm
Poliestireno 1.5mm (P)	___297P	___210P	___148P	___105P	
Vinilo adhesivo (A)		___210A	___148A	___105A	___60A

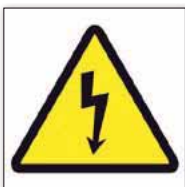

A01C



A110C



A111C

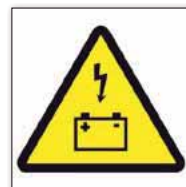

A87C



A71C



A02C



A03C



A04C



A05C



A61C

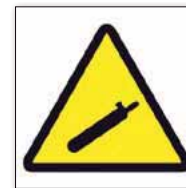

A40C



A47C



A07C



A43C

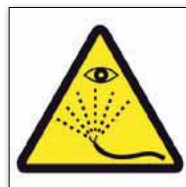

A96C



A10C



A08C



A38C



A06C



A09C



A30C



A12C

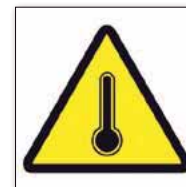

A11C



A31C



A32C



A93C



A13C



A50C

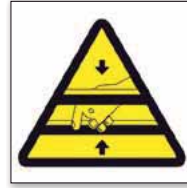

A35C



A34C



A85C



A42C



A21C



A92C



A91C



A211C



A68C



A76C



A25C



A79C



A251C



A39C



A26C



A27C



A88C



A89C



A16C



A69C



A14C



A94C



A95C



A70C



A28C



A33C



A65C



A86C







A22C



A24C



A56C



A23C

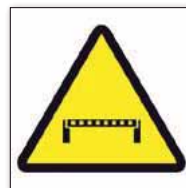

A77C



A78C



A81C



A73C



A74C



A75C



A98C



A55C



A80C



A19C



A17C



A18C



A20C

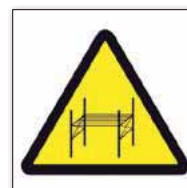

A72C



A29C



A46C



A36C



A48C



A37C



A99C

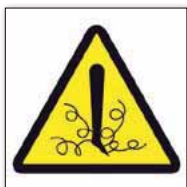

A52C



A53C



A54C



A97C



A84C



A15C



A100C



## ADVERTENCIA

### M | Triangular troquelada | Sólo pictograma

Este tipo de señales advierten de un riesgo y/o peligro. Su forma es triangular con el pictograma negro sobre fondo amarillo. Disponible en vinilo adhesivo.

#### Importante al hacer su pedido

1. Elija la señal que desee y anote la referencia y el formato.
2. Añada el código de tamaño de entre las medidas disponibles para este formato.
3. Por último, añada el código correspondiente al material.

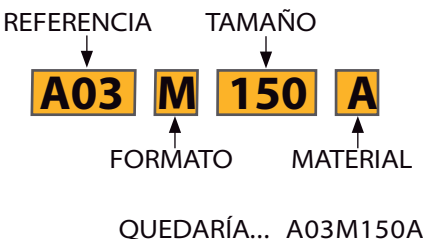

#### Medidas y materiales

MATERIAL \ MEDIDA	(X) = 150mm	(X) = 100mm	(X) = 70mm	(X) = 50mm
Vinilo adhesivo (A)	___150A	___100A	___70A	___50A

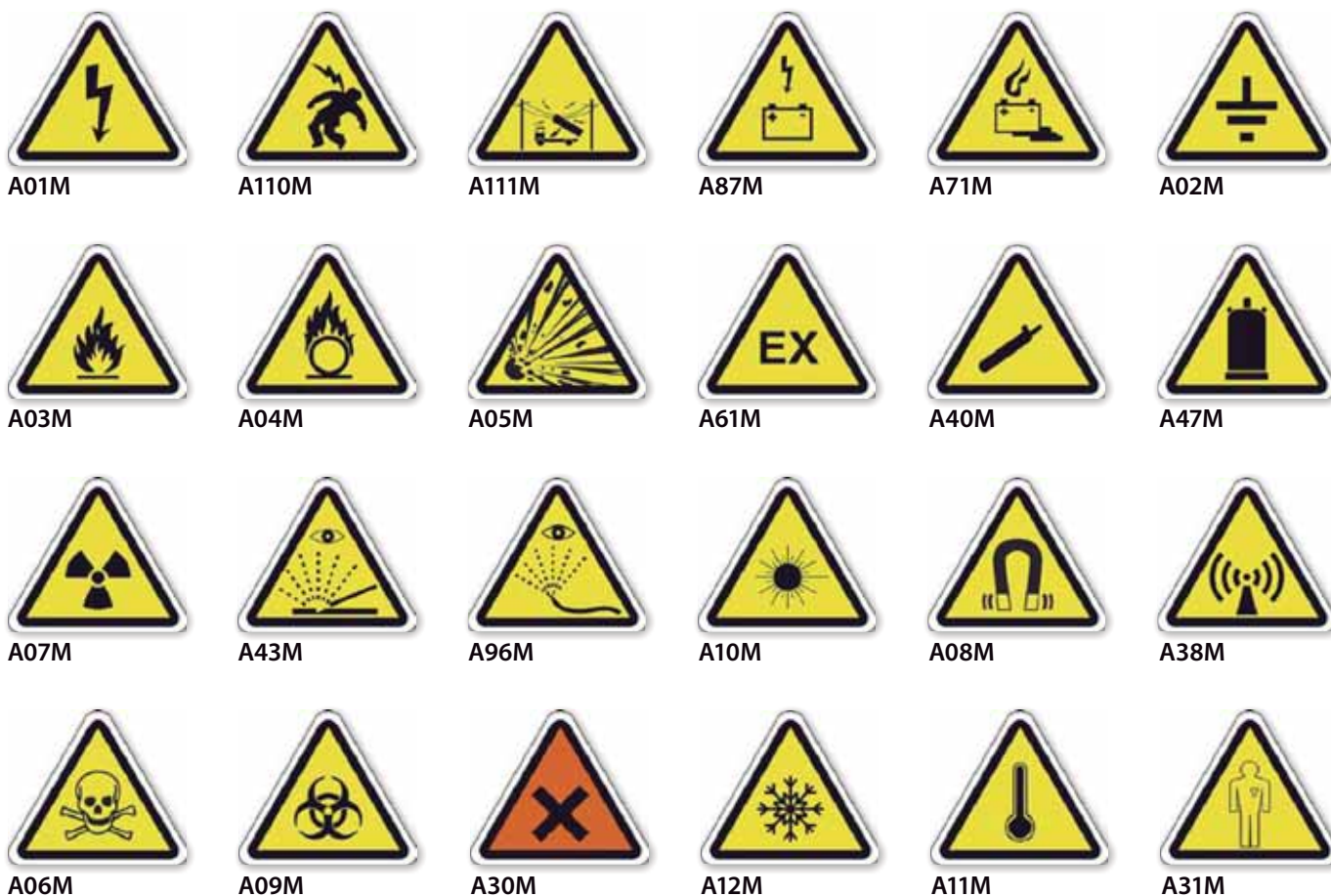





A32M



A93M



A13M



A50M



A35M



A34M



A85M



A42M



A21M



A92M



A91M



A211M



A68M



A76M



A25M



A79M



A251M



A39M



A26M



A27M



A88M



A89M



A16M



A69M



A14M



A94M



A95M



A70M



A28M



A33M



A65M



A86M





A22M



A24M



A56M



A23M



A77M



A78M



A81M



A73M



A74M



A75M



A98M



A55M



A80M



A19M



A17M



A18M



A20M



A72M



A29M



A46M



A36M



A48M



A37M



A99M



A52M



A53M



A54M



A97M



A84M



A15M



A100M





## ADVERTENCIA

### R | Rectangular | Pictograma y texto

Este tipo de señales advierten de un riesgo y/o peligro. Su forma es rectangular con el pictograma triangular con borde y silueta en color negro sobre fondo amarillo. Tiene texto aclaratorio en color negro sobre fondo amarillo. Disponible en poliestireno de 1.5mm.

#### Importante al hacer su pedido

1. Elija la señal que desee y anote REFERENCIA TAMAÑO la referencia y el formato.
2. Añada el código de tamaño de entre las medidas disponibles para este formato.
3. Por último, añada el código correspondiente al material.



QUEDARÍA... A11R717P

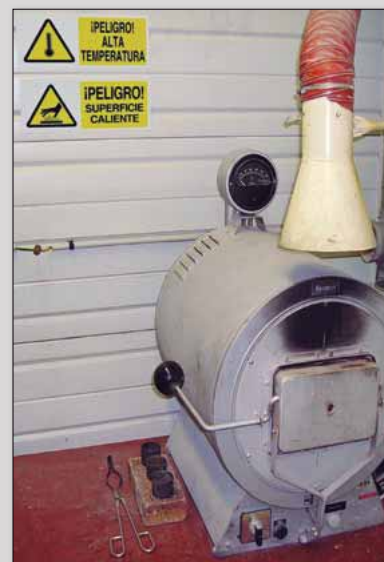

#### Medidas y materiales

MATERIAL	MEDIDA	717x297mm	507x210mm
Poliestireno 1.5mm (P)		___717P	___507P



A01R



A110R



A111R



A87R



A71R



A02R



A03R



A58R



A41R



A45R



A62R



A04R



A51R



A05R



A44R



A61R



A40R



A47R



A07R



A43R



A96R



A10R



A08R



A38R



A57R



A06R



A66R



A82R



A09R



A30R



A49R



A12R



A11R



A31R



A32R



A93R



A13R



A50R



A35R



A34R



A85R



A42R



A21R



A92R



A91R



A211R



A68R



A76R



A25R



A79R



A251R



A39R



A26R



A27R



A67R



A88R



A89R



A16R



A69R



A90R





A14R



A94R



A95R



A70R



A28R



A33R



A65R



A86R



A22R



A24R



A56R



A23R



A83R



A77R



A78R



A81R



A73R



A74R



A75R



A98R



A55R



A80R



A19R



A17R



A18R





A20R



A72R



A29R



A63R



A64R



A46R



A36R



A48R



A37R



A99R



A52R



A53R



A54R



A97R



A84R



A15R



A100R





## ADVERTENCIA

### T | Formato apaisado | Sólo texto

Estas señales advierten de riesgo y/o peligro. Formato rectangular de texto apaisado en color negro sobre fondo amarillo. En poliestireno de 1.5mm.

#### Importante al hacer su pedido

1. Elija la señal que desee y anote la referencia y el formato.
2. Añada el código de tamaño de entre las medidas disponibles para este formato.
3. Por último, añada el código correspondiente al material.

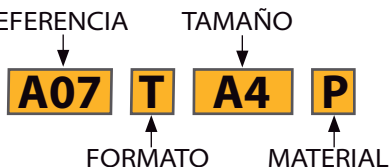

QUEDARÍA... A07TA4P



#### Medidas y materiales

MATERIAL	MEDIDA	DIN A3 420x297mm	DIN A4 297x210mm
Poliestireno 1.5mm (P)		___A3P	___A4P



A01T



A110T



A111T



A87T



A71T



A02T



A03T



A58T



A41T



A45T



A62T



A04T



A51T



A05T



A44T



A61T



A40T



A47T



A07T



A43T



A96T



A10T



A08T



A38T



A57T



A06T



A66T



A82T



A09T



A30T



A49T



A12T



A11T



A32T



A93T



A13T



A50T



A35T



A34T



A85T



A42T



A21T



A92T



A91T



A68T



A76T



A25T



A79T



A251T



A39T



A26T



A27T



A67T



A88T



A89T



A16T



A69T



A90T



A14T



A94T



A95T



A70T



A28T



A33T



A65T



**¡PELIGRO!  
RIESGO DE  
ATROPELLO**

A86T

**¡PELIGRO!  
PASO DE  
CARRETILLAS**

A22T

**¡PELIGRO!  
MAQUINARIA  
PESADA EN  
MOVIMIENTO**

A24T

**MANTENERSE ALEJADO  
DEL SISTEMA  
ARTICULADO DEL CAZO**

A56T

**¡PELIGRO!  
SALIDA DE  
CAMIONES**

A23T

**ENTRADA Y  
SALIDA DE  
CAMIONES**

A83T

**¡PELIGRO!  
BARRERA**

A77T

**¡PELIGRO!  
MUELLE**

A78T

**¡PELIGRO!  
TRANSITO DE  
VEHÍCULOS**

A81T

**¡PELIGRO!  
SOLO  
MANIPULACIÓN  
MECÁNICA**

A73T

**¡PELIGRO!  
PASO  
DE TREN**

A74T

**¡PELIGRO!  
SUELO  
IRREGULAR**

A75T

**PELIGRO  
TOLVAS**

A98T

**¡ATENCIÓN!  
PESO LIMITADO  
A KG**

A55T

**¡PELIGRO!  
PUENTE  
GRUA MOVIL**

A80T

**¡PELIGRO!  
CARGAS  
SUSPENDIDAS**

A19T

**¡PELIGRO!  
CAÍDA DE  
OBJETOS**

A17T

**¡PELIGRO!  
ZONA DE CARGA  
Y DESCARGA**

A18T

**¡PELIGRO!  
DESPRENDIMIENTOS**

A20T

**¡PELIGRO!  
ANDAMIO EN  
MAL ESTADO**

A72T

**PELIGRO  
INDETERMINADO**

A29T

**FUERA DE  
SERVICIO**

A63T

**¡ATENCIÓN!  
NO UTILICE ESTA MAQUINA  
SIN ESTAR AUTORIZADO Y  
CONOCER PERFECTAMENTE  
SU FUNCIONAMIENTO**

A64T

**¡PELIGRO!  
ENCENDIDO  
AUTOMÁTICO**

A46T

**¡ATENCIÓN!  
MÁQUINA EN  
REPARACIÓN**

A36T

**¡ATENCIÓN!  
RIESGO DE  
SALPICADURAS**

A48T

**PELIGRO DE  
ATRAPAMIENTO  
Y PROYECCIÓN  
DE PARTÍCULAS**

A37T

**¡PELIGRO!  
PROYECCIÓN  
DE PARTÍCULAS**

A99T

**¡PELIGRO!  
DESPRENDIMIENTO  
DE VIRUTA**

A52T

**¡ATENCIÓN!  
ALTA PRESIÓN**

A53T

**¡PELIGRO!  
POSIBLE ROTURA  
DE SIERRA**

A54T

**¡PELIGRO!  
ALAMBRE  
DE ESPINO**

A97T

**¡ATENCIÓN!  
ALARMA  
CONECTADA**

A84T

**¡PRECAUCIÓN!  
PERROS**

A15T

**¡PELIGRO!  
ABEJAS**

A100T

**NO ACERCARSE  
AL RADIO DE ACCIÓN  
DE LA MAQUINA**

A59T

**¡ATENCIÓN!  
PERSONAS  
TRABAJANDO**

A60T

## ADVERTENCIA

### Riesgo eléctrico | Formato apaisado | Pictograma y texto

Este tipo de señales advierten de un riesgo y/o peligro eléctrico. Es de forma rectangular con el texto en color negro y el pictograma negro o rojo sobre fondo amarillo.

Disponible en poliestireno de 1.5mm o vinilo adhesivo.

#### Medidas y materiales

MATERIAL	MEDIDA	Din A3 420x297mm	Din A4 297x210mm	Din A5 210x148mm	Din A6 148x105mm	80x60mm
Poliestireno 1.5mm (P)		___ A3P	___ A4P	___ A5P	___ A6P	
Vinilo adhesivo (A)			___ A4A	___ A5A	___ A6A	___ 80A

#### Importante al hacer su pedido

1. Elija la señal que desee y anote la referencia y el formato.
2. Añada el código de tamaño de entre las medidas disponibles para este formato.
3. Por último, añada el código correspondiente al material.

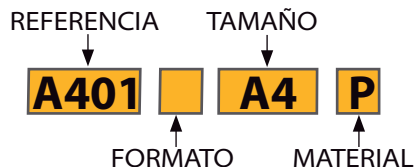

QUEDARÍA... A401A4P





## ADVERTENCIA - OBLIGACIÓN

### CAO | Rectangular | Pictograma y texto

Debido a la complejidad de algunos riesgos, cuando estos requieran más de un tipo de señal, ponemos a su disposición la perfecta solución con esta señal de advertencia-obligación.  
 Disponible en poliestireno de 1.5mm.

#### Importante al hacer su pedido

1. Elija la señal que desee y anote la referencia y el formato.
2. Añada el código de tamaño de entre las medidas disponibles para este formato.
3. Por último, añada el código correspondiente al material.

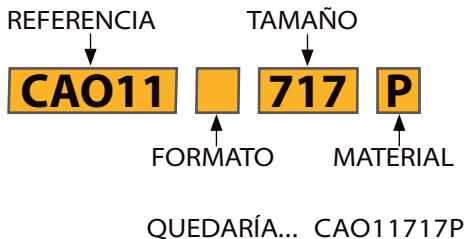

#### Medidas y materiales

	MEDIDA	717x297mm	507x210mm
MATERIAL			
Poliestireno 1.5mm (P)		___717P	___507P

<p>CAO01</p>	<p>CAO02</p>	<p>CAO03</p>	<p>CAO04</p>
<p>CAO05</p>	<p>CAO06</p>	<p>CAO07</p>	<p>CAO08</p>
<p>CAO09</p>	<p>CAO10</p>	<p>CAO11</p>	<p>CAO12</p>
<p>CAO13</p>	<p>CAO14</p>	<p>CAO15</p>	<p>CAO16</p>
<p>CAO17</p>	<p>CAO18</p>	<p>CAO19</p>	<p>CAO20</p>



## ADVERTENCIA - PROHIBICIÓN

### CAP | Rectangular | Pictograma y texto

Cuando el riesgo requiera más de un tipo de señal, le ofrecemos la perfecta solución con esta señal de advertencia-prohibición. En poliestireno de 1.5mm.

#### Medidas y materiales

MEDIDA	717x297mm	507x210mm
MATERIAL		
Poliestireno 1.5mm (P)	___717P	___507P

#### Importante al hacer su pedido

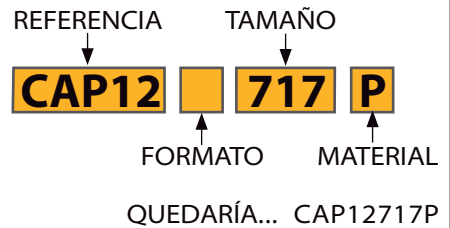





CAP21



CAP22



CAP23



CAP17



CAP25



CAP26



CAP27



CAP18



CAP29



CAP30



CAP31



CAP19



CAP20



CAP24



CAP28



## SOCORRO

### Formato DIN | Pictograma y texto

Estas señales sirven para indicar la ubicación de los equipos de lucha contra incendios. El pictograma debe ser blanco sobre fondo rojo.  
 Disponible en PVC rígido de 1.4mm luminiscente **Clase B** + Barniz o vinilo adhesivo.



### Importante al hacer su pedido

1. Elija la señal que desee y anote la referencia y el formato.
2. Añada el código de tamaño de entre las medidas disponibles para este formato.
3. Por último, añada el código correspondiente al material.

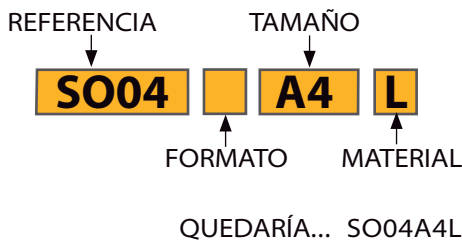

### Medidas y materiales

MATERIAL \ MEDIDA	Din A3 297x420mm	Din A4 210x297mm	Din A5 148x210mm	Din A6 105x148mm	60x80mm
PVC 1.4mm fotoluminiscente (L)	___ A3L	___ A4L	___ A5L	___ A6L	
Vinilo adhesivo (A)		___ A4A	___ A5A	___ A6A	___ 80A







S016



S017



S018



S019



S020



S021



S022



S043



S023



S024



S025



S026



S036



S037



S027



S038



S039



S034



S033



S050



S044



S045



S046



S047



S032



S053



S052



S056

## SOCORRO

### C | Cuadrada | Sólo pictograma

Indican la ubicación de los equipos de lucha contra incendios. Cuadrada con pictograma blanco sobre fondo rojo. Disponible en PVC rígido de 1.4mm luminiscente **Clase B** + Barniz o vinilo adhesivo.



#### Importante al hacer su pedido

1. Elija la señal que desee y anote la referencia y el formato.
2. Añada el código de tamaño de entre las medidas disponibles para este formato.
3. Por último, añada el código correspondiente al material.



#### Medidas y materiales

MATERIAL	MEDIDA	297x297mm	210x210mm	148x148mm	105x105mm	60x60mm
PVC 1.4mm fotoluminiscente (L)		___297L	___210L	___148L	___105L	
Vinilo adhesivo (A)			___210A	___148A	___105A	___60A

SO01C	SO02C	SO03C	SO04C	SO05C	SO06C
SO07C	SO08C	SO09C	SO10C	SO11C	SO12C
SO13C	SO14C	SO15C	SO16C	SO17C	SO18C
SO19C	SO20C	SO21C	SO22C	SO23C	SO24C



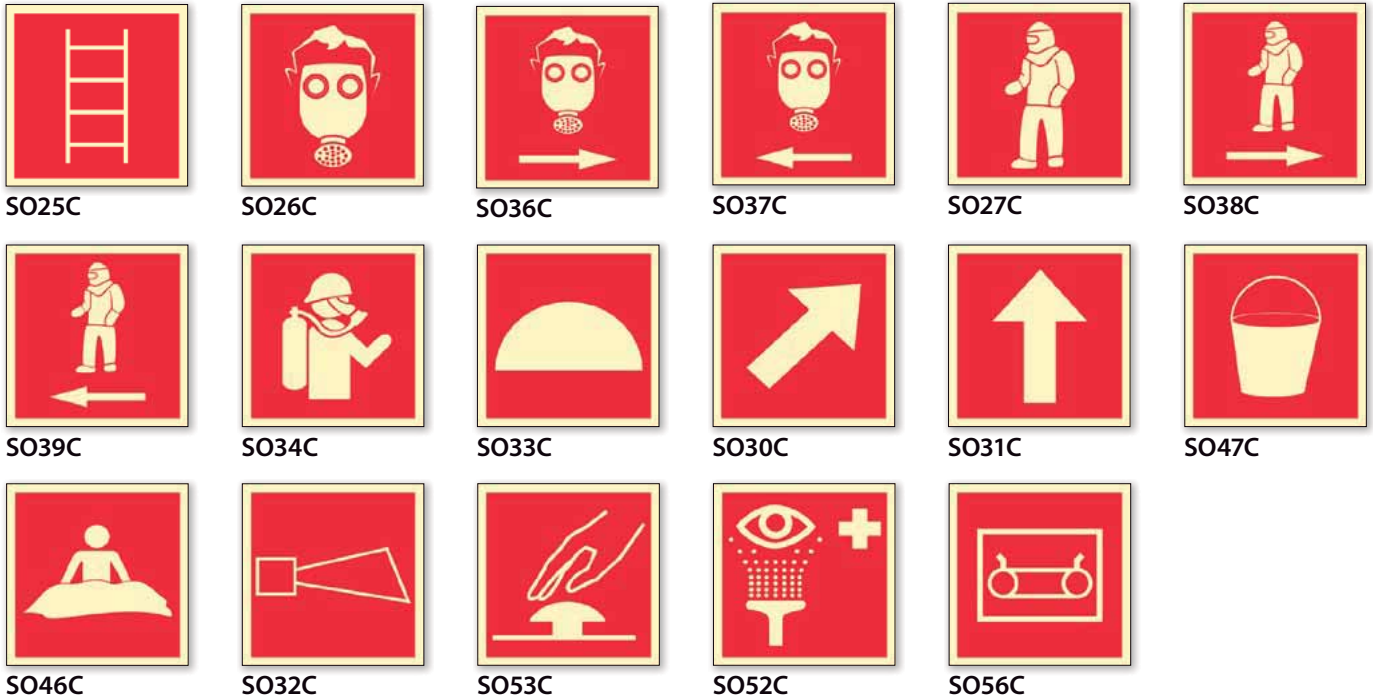

## SOCORRO

### SO | Formato apaisado | Sólo texto

Estas señales sirven para hacernos alguna indicación en caso de incendio o de cualquier otro tipo de emergencia. Disponible en PVC rígido de 1.4mm luminiscente **Clase B** + Barniz o vinilo adhesivo.

#### Importante al hacer su pedido

1. Elija la señal que desee y anote la referencia y el formato.
2. Añada el código de tamaño de entre las medidas disponibles para este formato.
3. Por último, añada el código correspondiente al material.

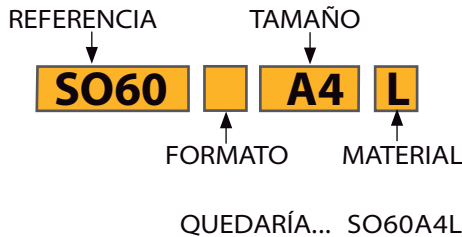

#### Medidas y materiales

MATERIAL \ MEDIDA	Din A3 420x297mm	Din A4 297x210mm	Din A5 210x148mm	Din A6 148x105mm	80x60mm
PVC 1.4mm fotoluminiscente (L)	___A3L	___A4L	___A5L	___A6L	
Vinilo adhesivo (A)		___A4A	___A5A	___A6A	___80A





SO49



SO51



SO54



SO58



SO59



SO60

## SOCORRO

### SO | Formato panorámico | Varias

Frente a las señales estándar que ofrecen solo una visión frontal, las señales panorámicas ofrecen una visión total desde cualquier ángulo. Además, al estar fabricadas con material luminiscente, de acuerdo con la normativa, se activan con cualquier fuente de luz y brillan en la oscuridad. Disponible en PVC rígido de 1.4mm luminiscente **Clase B** + Barniz.

#### Importante al hacer su pedido

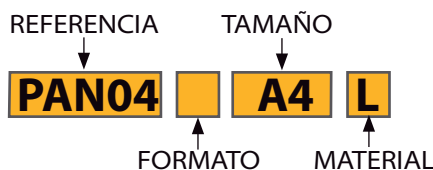

QUEDARÍA... PAN04A4L



PAN02



PAN05



PAN06



PAN07



PAN05C



PAN06C



PAN02C



PAN04C



PAN04



#### Medidas y materiales

MATERIAL	MEDIDA	Estandar 210x297mm	Formato C 210x210mm
PVC 1.4mm fotoluminiscente (L)		___ A4	___ C



## EVACUACIÓN

### EV | Formato DIN | Pictograma y texto

Este grupo de señales proporcionan indicaciones relativas a las salidas de evacuación, primeros auxilios o dispositivos de salvamento.  
Disponible en PVC rígido de 1.4mm luminiscente **Clase B** + Barniz o vinilo adhesivo.



#### Importante al hacer su pedido

1. Elija la señal que desee y anote la referencia y el formato.
2. Añada el código de tamaño de entre las medidas disponibles para este formato.
3. Por último, añada el código correspondiente al material.

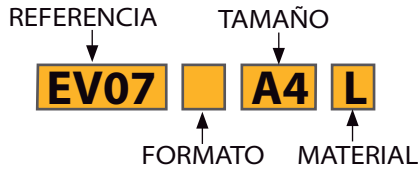

QUEDARÍA... EV07A4L

#### Medidas y materiales

MATERIAL / MEDIDA	Din A3 297x420mm	Din A4 210x297mm	Din A5 148x210mm	Din A6 105x148mm	60x80mm
PVC 1.4mm fotoluminiscente (L)	___A3L	___A4L	___A5L	___A6L	
Vinilo adhesivo (A)		___A4A	___A5A	___A6A	___80A





EV27



EV28



EV29



EV30



EV31



EV68



EV04



EV05



EV06



EV07



EV08



EV09



EV10



EV11



EV12



EV13



EV73



EV74



EV55



EV56



EV14



EV15



EV17



EV16



EV37



EV38



EV51



EV39



EV40



EV41



EV77



EV78



EV79



EV80



## EVACUACIÓN

### EV | Formato cuadrado | Sólo pictograma

Este grupo de señales proporcionan indicaciones relativas a las salidas de evacuación, primeros auxilios o dispositivos de salvamento.

Disponible en PVC rígido de 1.4mm luminiscente **Clase B** + Barniz o vinilo adhesivo.

#### Importante al hacer su pedido

1. Elija la señal que desee y anote la referencia y el formato.
2. Añada el código de tamaño de entre las medidas disponibles para este formato.
3. Por último, añada el código correspondiente al material.

REFERENCIA      TAMAÑO

↓                      ↓

**EV22**   **C**   **210**   **L**

                    ↑                  ↑

                    FORMATO            MATERIAL

QUEDARÍA... EV22C210L



#### Medidas y materiales

MATERIAL \ MEDIDA	297x297mm	210x210mm	148x148mm	105x105mm	60x60mm
PVC 1.4mm fotoluminiscente (L)	___297L	___210L	___148L	___105L	
Vinilo adhesivo (A)		___210A	___148A	___105A	___60A

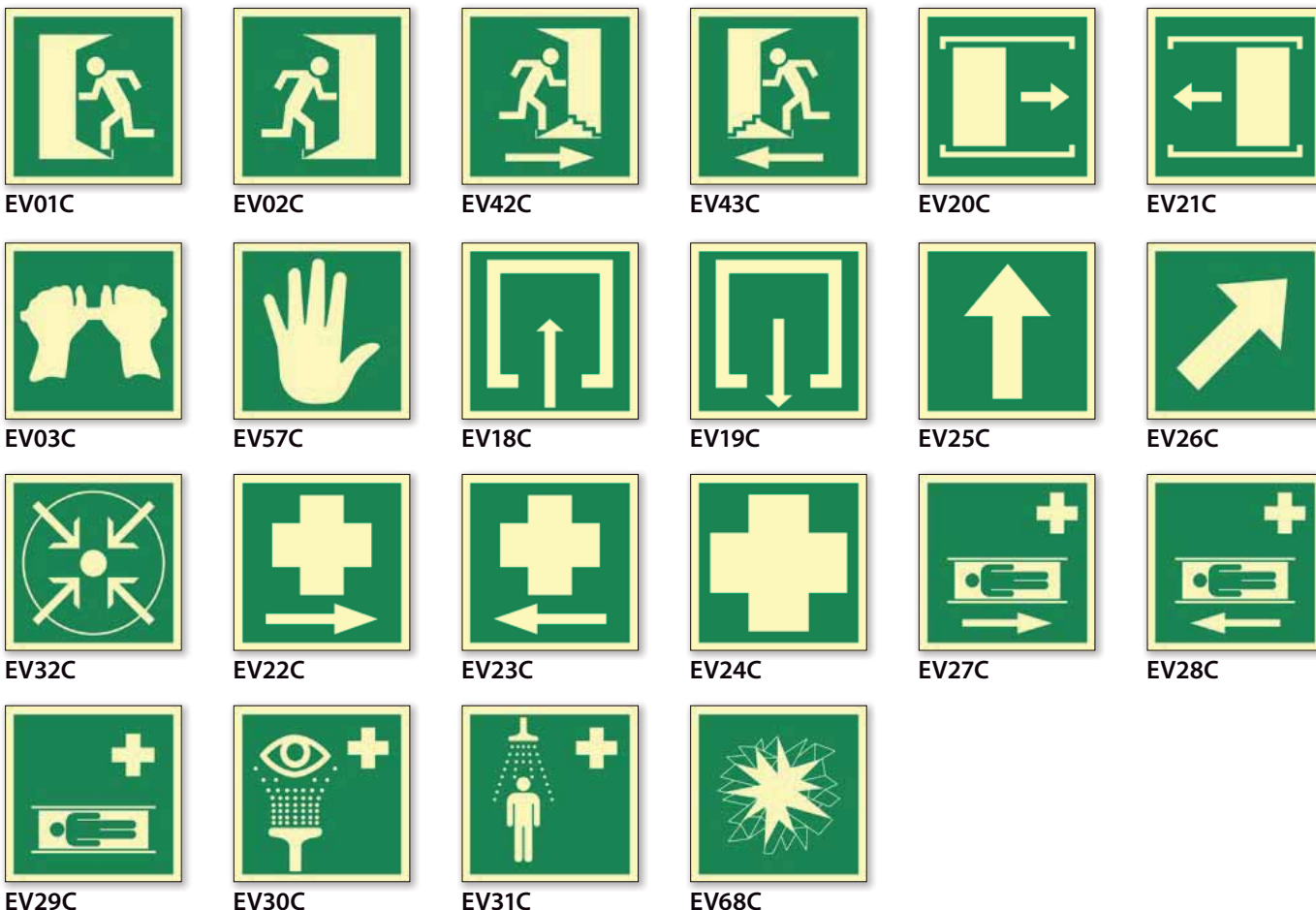

## EVACUACIÓN

### EV | Formato apaisado | Sólo texto

Este grupo de señales proporcionan indicaciones relativas a las salidas de emergencia y vías de evacuación. Fabricadas con material luminiscente de acuerdo con la normativa. Medidas: 400x100mm. Disponible en PVC rígido de 1.4mm luminiscente **Clase B** + Barniz.

#### Importante al hacer su pedido



EV33



EV34



EV47



EV58



EV45



EV46



EV69



EV81



EV35



EV36



EV59



EV44



EV75



EV76

### EV | Formato DIN | Pictograma y varios idiomas

Este grupo de señales proporcionan indicaciones relativas a las salidas de emergencia y vías de evacuación. Disponible en PVC rígido de 1.4mm luminiscente **Clase B** + Barniz o vinilo adhesivo. Formato DIN.

#### Importante al hacer su pedido



EV60



EV66



EV61



EV62



EV64



EV65



EV71



EV72



## EVACUACIÓN

### EV | Formato panorámico | Varias

Frente a las señales estándar que ofrecen solo una visión frontal, las señales panorámicas ofrecen una visión total desde cualquier ángulo. Fabricadas con material luminiscente, de acuerdo con la normativa. PVC rígido de 1.4mm luminiscente **Clase B** + Barniz.

#### Importante al hacer su pedido



MATERIAL	MEDIDA	Estandar 210x297mm	Formato C 210x210mm
PVC 1.4mm fotoluminiscente (L)		---A4	---C



PAN01



PAN08



PAN01C

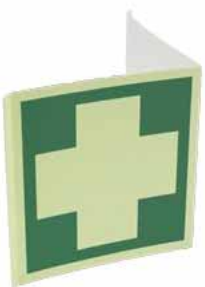

PAN08C

### Grippers para señales

Accesorios para la colocación de señales a doble cara con base adhesiva. Ideal para techo y pared.

Ref: Gripper 10	100mm	1x
Ref: Gripper 14	140mm	1x
Ref: Gripper 20	200mm	1x
Ref: Gripper 28	280mm	1x



## EVACUACIÓN / SOCORRO

### EV/SO | Varios formatos | Varias

Nuestras señales de evacuación o socorro de "Clase A", en cumplimiento de la normativa, son luminiscentes y se instalan preferentemente en lugares de concurrencia pública o con iluminación exclusivamente artificial: Centros comerciales, auditorios, hospitales, estaciones, etc...

Disponible en PVC fotoluminiscente de 1.4mm **Clase A** + Barniz.



#### Importante al hacer su pedido

1. Elija la señal que desee y anote la referencia y el formato.
2. Añada el código de tamaño de entre las medidas disponibles para este formato.
3. Por último, añada el código correspondiente al material.

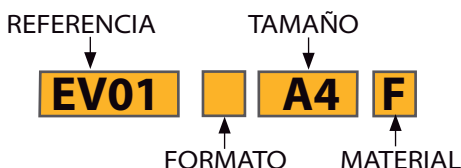

QUEDARÍA... EV01 A4F

#### Medidas y materiales

MEDIDA	Din A3 297x420mm	Din A4 210x297mm	Din A5 148x210mm
MATERIAL	___ A3F	___ A4F	___ A5F



EV01



EV02



EV32



EV03



EV31



EV30



EV22



EV23



EV24



EV29



EV42



EV43



EV48



EV49



EV50



EV52



EV57



EV26





EV25



EV04



EV05



EV06



EV07



EV08



EV09



EV10



EV11



EV12



EV13



EV14



EV15



EV16



EV17



EV37



EV38



EV39



EV40



EV41



EV51



EV55



EV56



EV73



EV74



EV77



EV78





S001 S002 S003 S004 S007 S008 S009



S010 S011 S012 S015 S019 S020 S021



S022 S025 S026 S032 S033 S034 S041



S042 S043 S046 S050 S053 S056 S057



S028 S029 S035 S040 S048

### Importante al hacer su pedido

1. Elija la señal. Anote la referencia y el formato.
2. Añada el código de tamaño.
3. Por último, añada el código correspondiente al material.

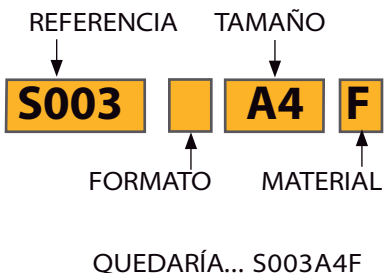

MATERIAL	PVC luminiscente (F)
Din A3 297x420mm	--- A3F
Din A4 210x297mm	--- A4F
Din A5 148x210mm	--- A5F



S051



S054



## PLANOS DE EVACUACIÓN

### EV | Formato apaisado | Texto y pictogramas

Presenta de forma clara el procedimiento en caso de incendio, las vías de evacuación, así como los medios de lucha contra incendios.

Estos planos se pueden enmarcar. Fabricado en PVC fotoluminiscente **Clase A**.

**Plano de evacuación**  
Evacuation plan

**Legend:**

- USTED ESTA AQUÍ / YOU ARE HERE / SIE BEFINDEN SICH HIER / VOUS ÊTES ICI
- BOCA DE INCENDIO / HYDRANT / FEUERLOSCHANSCHLUSS / BOUCHE D'INCENDIE
- EXTINTOR / FIRE-EXTINGUISHER / LAGE DES LÖSCHGERÄTES / EXTINCTEUR
- PULSADOR ALARMA / ALARMA PUSH-BUTTON / ALARMKNOPF / BOUTON D'ALARME
- SALIDA DE EMERGENCIA / EMERGENCY EXIT / NOTAUSGANG / SORTIER DE SECOURS

**EN CASO DE INCENDIO**

- Informe rápidamente de la situación del fuego a recepción
- No pierda la calma, no corra ni grite, fíjese en el suelo y ruede si se prende su ropa, camine a gatas si hay abundante humo
- Cierre la puerta cuando abandone la habitación
- Si las salidas están bloqueadas no utilice los ascensores
- Permanezca en la habitación, colocando ropas húmedas en las ranuras de las puertas
- Hágase ver por las ventanas

**IN THE EVENT OF FIRE**

- Quickly report the fire at the reception desk
- Keep calm, don't shout
- Close the door when you leave the room
- If the exits are blocked do not use the elevators
- Remain in the room, placing wet clothes in the gaps of the doors
- Make yourself visible through the windows

**IN BRANDFALL**

- Informieren Sie de Rezeption Umgebene von dem Brand
- Behalten Sie Ruhe, rennen und schreien Sie nicht, wenn Ihre Kleidung Feuer gefangen hat, wälzen Sie sich auf dem Boden, bei starker Rauchentwicklung, bewegen Sie sich kriechend vorwärts
- Schliessen Sie die Tür wenn Sie das Zimmer verlassen
- Benutzen Sie nicht die Aufzüge wenn die Ausgänge blockiert sind
- Bleiben Sie im Zimmer und machen Sie sich durch die Türspalten bemerkbar

**EN CAS D'INCENDIE**

- Informez rapidement la réception de la localisation du feu
- Ne perdez pas votre calme, ne courez pas, ne criez pas, attendez feu avancez à quatre pattes si la fumée est abondante

**Plano general de Evacuación**  
Salidas de emergencia y equipos de protección contra incendios

**Legend:**

- Extintor
- Timbre de alarma
- Manguera
- Hidrante
- Salida de Emergencia
- Punto de reunión

**Legend:**

- Extintor
- Timbre de alarma
- Manguera
- Hidrante
- Salida de Emergencia
- Punto de reunión



## NORMATIVA EUROPEA EN ISO 7010

### Ya puede solicitar la señalética adaptada a la normativa europea EN ISO 7010

Aunque toda la señalización dispensada hasta la fecha (UNE 23033 y 23034) que se verá afectada por esta actualización sigue siendo perfectamente válida además de obligatoria, ya puede solicitar señalética adaptada a la nueva normativa europea EN ISO 7010 que se irá implantando poco a poco.

En cualquier caso la colección de pictogramas de la nueva ISO todavía es pequeña respecto a la colección vigente y probablemente esta no se implantará hasta dentro de unos cuantos meses.

La norma EN ISO 7010 no contempla fotoluminiscencia por lo tanto los niveles de UNE 23035 siguen siendo válidos.



### CÓDIGO TÉCNICO DE EDIFICACIÓN (CTE)





## CATALÁN

### CAT | Formato DIN | Pictograma y texto

Tenemos a su disposición un amplio surtido de las señales más habituales en catalán. Para otras lenguas consulte existencias. Disponible en poliestireno de 1.5mm.

#### Importante al hacer su pedido

1. Elija la señal que desee y anote la referencia y el formato.
2. Añada el código de tamaño de entre las medidas disponibles para este formato.
3. Por último, añada el código correspondiente al material.

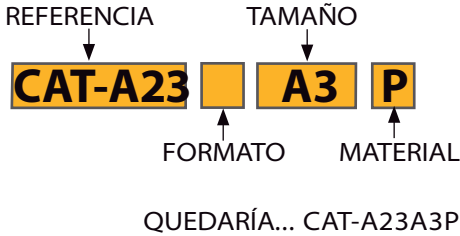

MATERIAL	MEDIDA	Din A3 420x297mm	Din A4 297x210mm
Poliestireno 1.5mm (P)		___A3P	___A4P



CAT-A01



CAT-A03



CAT-A04



CAT-A05



CAT-A17



CAT-A19



CAT-A21



CAT-A23



CAT-A24



CAT-A26



CAT-A27



CAT-A28



CAT-A30



CAT-A33



CAT-A41



CAT-A58



CAT-A69



CAT-001



CAT-O02



CAT-O03



CAT-O09



CAT-O11



CAT-O14



CAT-O25



CAT-O29



CAT-O30



CAT-O40



CAT-O58



CAT-O62



CAT-P01



CAT-P03



CAT-P05



CAT-P51



CAT-P52



CAT-P29



CAT-P59



CAT-P40



CAT-P21



CAT-P22



CAT-P24



CAT-P45



CAT-SO03



CAT-SO04



CAT-SO55



CAT-SO09



CAT-SO10



CAT-SO11



CAT-SO22



CAT-SO32



CAT-SO34



CAT-SO28



CAT-SO29



## EVACUACIÓN

## CAT | Formato DIN | Pictograma y texto

Tenemos a su disposición un amplio surtido de las señales más habituales en catalán. Para otras lenguas consulte existencias. Disponible en PVC rígido de 1.4mm luminiscente **Clase B** + Barniz.

**Importante al hacer su pedido**

1. Elija la señal que desee y anote la referencia y el formato.
2. Añada el código de tamaño de entre las medidas disponibles para este formato.
3. Por último, añada el código correspondiente al material.

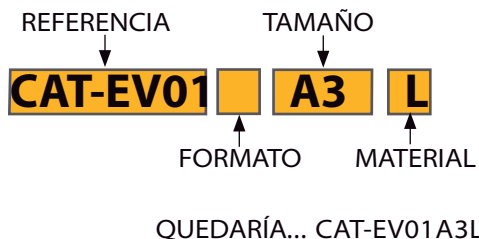

MATERIAL	MEDIDA	Din A3 420x297mm	Din A4 297x210mm
PVC 1.4mm fotoluminiscente (L)		___A3L	___A4L



CAT-EV01



CAT-EV02



CAT-EV24



CAT-EV32



CAT-EV10



CAT-EV11



CAT-EV14



CAT-EV17



CAT-EV39



CAT-EV33



CAT-EV35



CAT-EV36



CAT-EV47



CAT-PAN02



CAT-PAN09



CAT-PAN04



CAT-PAN01

## ALUMINIO

### AL | Formato DIN | Pictograma y texto

Ponemos a su disposición las señales más habituales en aluminio lacado en blanco. Este acabado le confiere a la señal una mayor resistencia frente a impactos y a su vez prolonga su durabilidad. Disponible en aluminio lacado en blanco de 1mm.

#### Importante al hacer su pedido

1. Elija la señal que desee y anote la referencia y el formato.
2. Añada el código de tamaño de entre las medidas disponibles para este formato.
3. Por último, añada el código correspondiente al material.

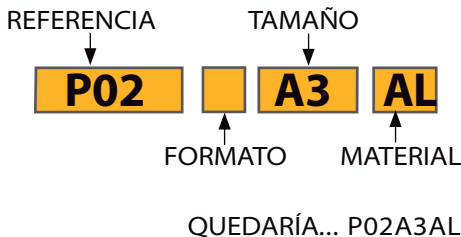

MATERIAL \ MEDIDA	Din A3 420x297mm	Din A4 297x210mm
Aluminio lacado en blanco	---A3AL	---A4AL



O01



O02



O06



O03



O06



O14



O60



O09



O11



O66



O25



P21



P01



P02



P05



P52



P03



P41





P29



P31



A01



A03



A04



A05



A17



A18



A19



A20



A22



A23



A24



A28



A251



A39



A26



A27



A29



A58



A61



A66



SO03



SO07



SO11



SO15



SO22



SO29



SO42



EV01



EV02



EV24



EV29



EV30



EV31



EV32

## RECICLAJE

### REC | Formato rectangular | Pictograma y texto

Tenemos a su disposición las principales señales para la correcta identificación de las distintas cadenas de reciclaje.

Disponible en poliestireno 1.5 mm o vinilo adhesivo.

MATERIAL	MEDIDA	Din A4 210x297mm
Poliestireno 1,5mm		___ A4P
Vinilo adhesivo		___ A4A



REC01



REC02



REC03



REC04



REC05



REC06

## ESPECIAL LEY ANTITABACO

### ES | Varias

Estas señales proporcionan las indicaciones relativas a la ley antitabaco, vigente desde 2011. Fabricadas en poliestireno de 1.5mm o en vinilo adhesivo.

#### Medidas y materiales

MATERIAL	MEDIDA	Din A3 420x297mm	Din A4 297x210mm	Din A5 210x148mm	Din A6 148x105mm
Poliestireno 1.5mm (P)		___ A3P	___ A4P	___ A5P	___ A6P
Vinilo adhesivo (A)			___ A4A	___ A5A	___ A6A



P21



O27



ES-1C



ES-2C



ES-3C



ES-4C



O27L2



P21L



O27L



P21T



O27T

#### Vinilo adhesivo

 I08N  
(250x170mm y 175x120mm)

 I09N  
(250x170mm y 175x120mm)

 O27R  
(717x297mm y 507x210mm)

 P21R  
(717x297mm y 507x210mm)

#### Poliestireno

#### Glasspack

 I09  
(250x62mm y 175x45mm)

 I08  
(250x62mm y 175x45mm)



## ACCESORIAS

### AC | Formato apaisado | Sólo texto

Carteles anunciadores fabricados en poliestireno, impresos en serigrafía y con dígitos modulares en algunos casos. Señales que le aportan una gran eficacia en el mensaje que quiere transmitir. Fabricada en poliestireno de 1.5 mm.

#### Importante al hacer su pedido

1. Elija la señal que desee y anote la referencia y el formato.
2. Añada el código de tamaño de entre las medidas disponibles para este formato.
3. Por último, añada el código correspondiente al material.

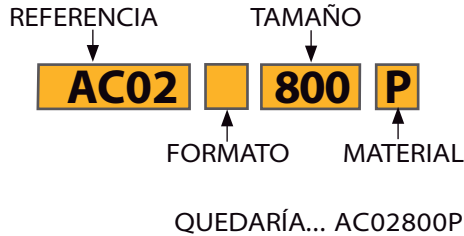

MATERIAL \ MEDIDA	800x500mm	500x400mm	Din A3 420x297mm	Din A4 297x210mm
Poliestireno 1.5mm (P)	___800P	___500P	___A3P	___A4P



AC01



AC05



AC09



AC03



AC07



AC02



AC06



AC10



AC04



AC08



AC11



AC12



AC14 (A4 y A5)



AC15 (A4 y A5)



AC17 (A4 y A5)



AC16 (A4 y A5)



## ACCESORIAS

### AC | Formato apaisado | Sólo texto

Señales accesorias de edificios para colocar sobre puertas, paredes o cualquier otro soporte para la correcta identificación dentro de él.

Disponible glasspack 0.4mm, aluminio plateado y aluminio dorado.

#### Acabados: 250 x 62mm



GLASSPACK

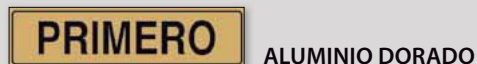

ALUMINIO DORADO



ALUMINIO PLATEADO

#### Acabados: 62 x 62mm



GLASSPACK



ALUMINIO DORADO



ALUMINIO PLATEADO

#### Marcos ABS



250x62 mm  
Ref.: 00800303

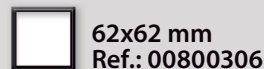

62x62 mm  
Ref.: 00800306



AC18



AC19



AC20



AC21



AC22



AC23



AC24



AC25



AC26



AC27



AC28



AC29



AC30



AC31



AC32



AC33



AC34



AC35



AC36



AC37



AC38



AC39



AC40



AC41



AC42



AC43



AC44



AC45



AC46



AC47



AC48



AC49



AC50



AC51



AC52



AC53



AC54



AC55



AC56



AC57

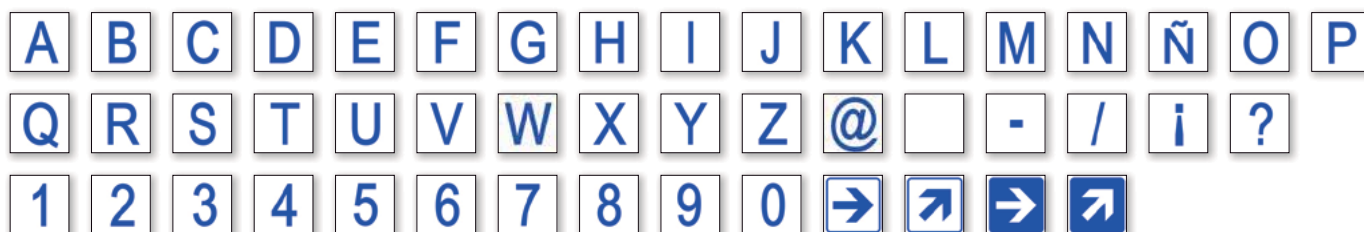

AC + SIMBOLO



## INFORMATIVAS

### | Formato apaisado | Varias

Amplio catálogo de señalización informativa para edificios y lugares públicos, hoteles, comunidades de vecinos, señalización para baños, entradas a viviendas particulares, fincas privadas, etc...  
 Disponible en glasspack, aluminio dorado y aluminio plateado.

#### Medidas y materiales

MATERIAL \ MEDIDA	250x62mm	175x44mm
Glasspack (G)	___250G	___175G
Aluminio dorado (AO)	___250AO	___175AO
Aluminio plateado (AP)	___250AP	___175AP

#### Acabados



I51	I52	I53	I54	I55
I56	I57	I58	I59	I60
I61	I62	I63	I64	I65
I66	I67	I68	I69	I70
I71	I72	I73	I74	I75
I76	I77	I78	I79	I80
I81	I82	I83	I84	I85
I86	I87	I88	I89	I90
I91	I92	I93	I94	I95
I96	I97	I98	I99	I100
I101	I102	I103	I104	

## MARCOS ABS

Mejore notablemente la estética de sus señales informativas con nuestros marcos protectores. Con una sencilla instalación alargará la vida de cada señal y además estará protegida contra cualquier acto vandálico.

 250x62 mm  
Ref.: 00800303

 175x44 mm  
Ref.: 00800304



Señal "I10250AP" en aluminio plateado con marco ABS ref. 00800303



## VARIAS

## V | Formato cuadrado | Sólo pictograma

Amplio catálogo de señalización válido para edificios y lugares públicos, hoteles, comunidades de vecinos, señalización para baños, entradas a viviendas particulares, fincas privadas, etc...

Disponible en poliestireno, aluminio dorado y aluminio plateado.

## Medidas y materiales

MATERIAL	MEDIDA	148x148mm
Poliestireno 1.5mm	___148P	
Aluminio dorado	___148AO	
Aluminio plateado	___148AP	

## Acabados



POLIESTIRENO



ALUMINIO PLATEADO



ALUMINIO DORADO

MARCO ABS  
Ref.: 00800305

V01



V02



V03



V04



V05



V06



V07



V08



V09



V10



V11



V12



V13



V14



V15



V16



V17



V18



V19



V20



V21



V22



V23

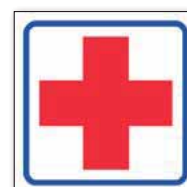

V24



V25



V26



V27

## SEÑALIZACIÓN ESPECIAL

Tenemos a su disposición un surtido de las señales especiales más habituales. Disponible en diferentes materiales, pensados para adaptarse a las necesidades propias de cada señal.

### Poliestireno



0080014  
(Din A4)



0080022  
(Din A4)

### Poliestireno y vinilo adhesivo



VV01  
(Din A4 y Din A5)

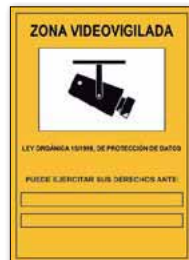

VV02  
(Din A4 y Din A5)



OB27  
(Din A3 y Din A4)



0080018  
(297x148mm)



0080017  
(297x148mm)

### Glasspack

### Poliestireno y vinilo



0080019  
(105x105mm)  
(148x148mm)

### Vinilo transparente espejo



0080013  
(Din A6)

### Aluminio de 1mm

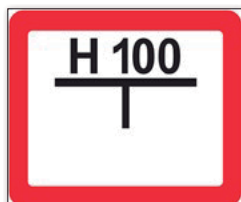

0080020  
(250x200mm)



0080016  
(300x200mm)

### Glasspack



0080015  
(Din A4)

## CÍRCULOS ADHESIVOS PARA CRISTALES

Perfectos para identificar cristaleras o puertas de cristal y así evitar posibles accidentes. Disponible en colores estándar rojo y verde con unas medidas de 100 y 150mm de diámetro. Para otros colores y medidas, consúltenos.

Ref:	CIR100	Ø 100mm		1x
Ref:	CIR150	Ø 150mm		1x



## SEÑALIZACIÓN SEGÚN NORMATIVA "AMYS"

### AMYS | Formato rectangular

Estas señales establecen un procedimiento básico de primeros auxilios a seguir en caso de una maniobra RCP (Reanimación Cardio-Pulmonar) u otras emergencias en instalaciones eléctricas, centros de trabajo o instaladores electricistas en alta y baja tensión.

Disponibles en poliestireno de 1.5mm o vinilo adhesivo. Medidas: Din A3 y Din A4.



AMYS01



AMYS02



AMYS03



AMYS04



AMYS05



## MATERIAS PELIGROSAS

### MP | Formato rombo | Sólo pictograma

Las materias peligrosas incluyen explosivos, varios tipos de gases, sólidos, líquidos inflamables y combustibles, entre otros. Tenemos a su disposición un amplio surtido de las señales más habituales en este ámbito. Disponible en vinilo adhesivo.

MATERIAL	MEDIDA	100mm lado	300mm lado
Vinilo adhesivo		___100A	___300A



MP01



MP02



MP03



MP04



MP06



MP08



MP09



MP10



MP11



MP12



MP14



MP15



MP41



MP17



MP18



MP19



MP20



MP21



MP22



MP23



MP24



MP25



MP31



MP42

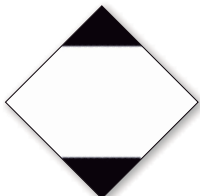

MP43



MP29 (150x105mm)

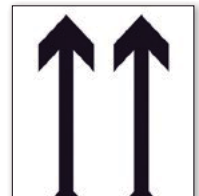

MP30 (150x105mm)



MP26 (300x300mm)



MP27 (105x90mm)



MP28 (105x90mm)



## PRODUCTOS QUÍMICOS

### MP | Formato rombo | Sólo pictograma

Tenemos a su disposición las principales señales para la correcta identificación de los riesgos que pueden ocasionar los diferentes productos químicos en áreas de almacenaje. Disponible en vinilo adhesivo.

#### Importante al hacer su pedido

1. Elija la señal que desee y anote la referencia y el formato.
2. Añada el código de tamaño de entre las medidas disponibles para este formato.
3. Por último, añada el código correspondiente al material.

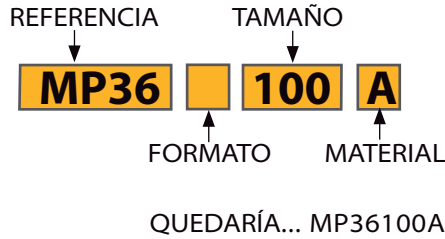

MATERIAL	MEDIDA	100mm lado
Vinilo adhesivo		___100A



MP32



MP33



MP34



MP35



MP36



MP37



MP38



MP39



MP40





## SEÑALIZACIÓN DE PELIGRO DE RADIACIÓN

### RAD | Formato DIN | Pictograma y texto

Todo espacio donde se manipulen o almacenen radionucleidos o se disponga de generadores de radiaciones ionizantes debe estar perfectamente delimitado y señalizado según lo establecido en la Norma UNE-73-302. La clasificación en distintos tipos de zonas se efectúa en función del riesgo existente en la instalación.

Disponible en poliestireno de 1.5mm o vinilo adhesivo. Tamaño DIN.

MATERIAL	MEDIDA	Din A4 210x297mm
Poliestireno 1.5mm		___ A4P
Vinilo adhesivo		___ A4A



RAD01

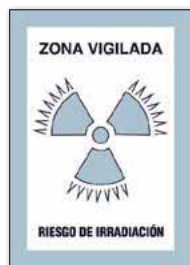

RAD02

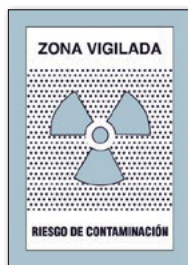

RAD03



RAD04



RAD05



RAD06



RAD07



RAD08



RAD09



RAD10



RAD11



RAD12



RAD13



RAD14



RAD15



RAD16



RAD17



RAD18



RAD19



RAD20



## SEÑALIZACIÓN DE TUBERÍAS

### TUB | Formato rectangular | Sólo pictograma

Etiquetas fabricadas en vinilo adhesivo, pensadas para identificar conductos o tuberías y saber qué líquido o gas transportan.

MATERIAL	MEDIDA	300x75mm	200x50mm
Vinilo adhesivo		___ 300	___ 200



TUB01  
(AGUA)



TUB02  
(OXÍGENO)

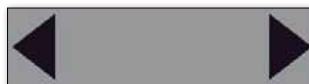

TUB03  
(AIRE)



TUB09  
(GASES NO COMBUSTIBLES)



TUB10  
(VAPOR DE AGUA)



TUB17  
(LEJÍAS)

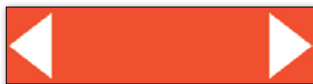

TUB18  
(ÁCIDOS)



TUB11  
(LÍQUIDOS COMBUSTIBLES)



TUB04  
(GASES COMBUSTIBLES)



## TARJETAS DE SEÑALIZACIÓN

Tarjetas fabricadas en glasspack de 0.4mm. Medidas: 203x83mm



T01



T02

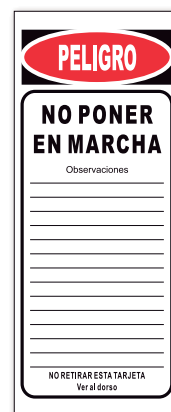
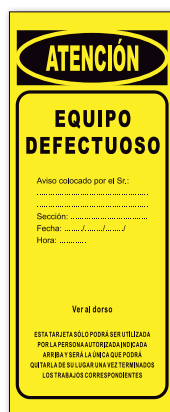

T03



T04

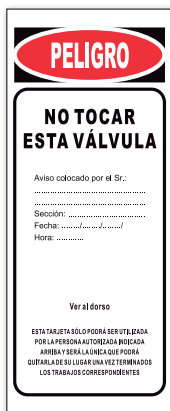

T05

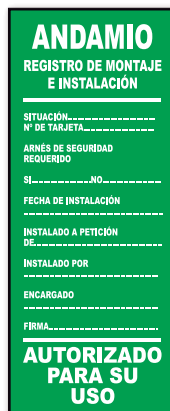

## SOPORTE PARA TARJETAS

Soporte para acoplar tarjetas de señalización fabricado en plaquene de 1.2mm.



T00



## OBRA

### OB

Cartel de obra estandar, reúne todas las señales de su empresa en una sola, estableciendo unas normas básicas de seguridad. Con posibilidad de personalizar. Disponible en poliestireno de 3mm y glasspack de 0.7mm.



OB01 Poliestireno 1.5 mm - (1000x700mm)

OB24 Glasspack 0.7 mm - (1000x700mm)



OB26 Glasspack 0.7 mm - (1000x700mm)



OB01 PS 1.5 mm - (1000x700mm)

Personalizable con espacio para logo de empresa y en catalán.



OB02 Glasspack 0.7 mm - (500x700mm)

**PERSONALIZAMOS SEÑALES DE OBRA O DE SEGURIDAD  
¡CONSÚLTENOS!**



EJEMPLO: 2000x2000mm  
CON NÚMEROS  
INTERCAMBIABLES

DÍGITOS MODULARES  
PARA CARTEL DE OBRA  
80, 160, 240mm

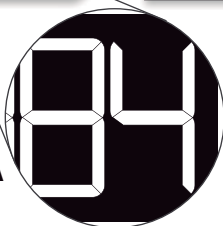

OB01X - (1000x800mm)  
(SEGÚN CANTIDAD Y  
BAJO PEDIDO)



OB23X - (500x700mm)  
(SEGÚN CANTIDAD Y  
BAJO PEDIDO)

## OBRA

### OB | Formato cuadrado | Sólo pictograma

Señales ligeras, resistentes y de fácil instalación. Material especialmente indicado para carteles y señales expuestos a la intemperie para su colocación en vallas. Fabricadas en polipropileno celular de 600x600mm.



OB03

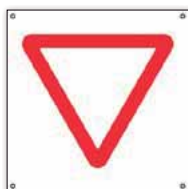

OB04

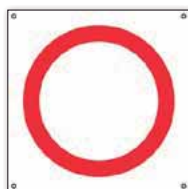

OB05



OB06



OB29



OB07



OB08



OB15



OB16



OB17

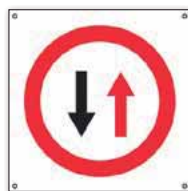

OB22

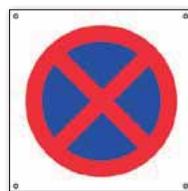

OB12



OB09



OB20



OB21



OB10



OB11



OB19



OB13

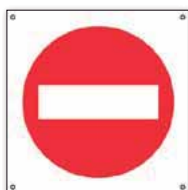

OB18

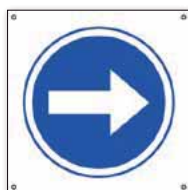

OB14



OB30

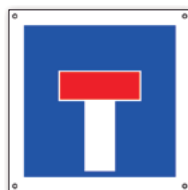

OB25



## CINTAS DE BALIZAMIENTO

Posibilidad de realizar cintas personalizadas, con texto a elegir, logos, etc. Pedido mínimo: 5000 metros.



**ROJA / BLANCA**  
0479001 - (BOBINA 8cm x 200 metros GALGA 200 PACK 5 rollos)



**ROJA / BLANCA**  
0479002 - (BOBINA 8cm x 250 metros GALGA 300 PACK 5 rollos)



**AMARILLA / NEGRA**  
0479004 - (BOBINA 8cm x 200 metros GALGA 200 PACK 5 rollos)



**AZUL / BLANCA**  
0479005 - (BOBINA 8cm x 200 metros GALGA 200 PACK 5 rollos)



**PASAR NO PASAR NO PASAR**  
NO PASAR  
0479014 - (BOBINA 8cm x 100 metros GALGA 300 PACK 5 rollos)



**PROHIBIDO EL PASO**  
0479015 - (BOBINA 8cm x 100 metros GALGA 300 PACK 5 rollos)



**BOMBEROS**  
0479018 - (BOBINA 8cm x 100 metros GALGA 300 PACK 5 rollos)



**NO PASAR LINEA DE POLICIA**  
LÍNEA DE POLICIA  
0479020 - (BOBINA 8cm x 100 metros GALGA 300 PACK 5 rollos)



**POLICIA LOCAL**  
POLICIA LOCAL  
0479021 - (BOBINA 8cm x 100 metros GALGA 300 PACK 5 rollos)



**POLICIA MUNICIPAL**  
POLICIA MUNICIPAL  
0479022 - (BOBINA 8cm x 100 metros GALGA 300 PACK 5 rollos)



**PROTECCIÓN CIVIL**  
PROTECCIÓN CIVIL  
0479024 - (BOBINA 8cm x 100 metros GALGA 200 PACK 5 rollos)



**TIRAS DE VINOLO ROJA / BLANCA**  
0479025 - (TIRA 10cm x 1 metro)



**TIRAS DE VINOLO AMARILLA / NEGRA**  
0479026 - (TIRA 10cm x 1 metro)

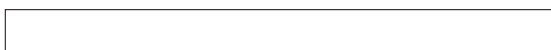

**TIRA VINOLO ADHESIVO REFLECTANTE BLANCA**  
0025029 - (TIRA 10cm x 1 metro)



**TIRA VINOLO ADHESIVO REFLECTANTE ROJA**  
0025030 - (TIRA 10cm x 1 metro)

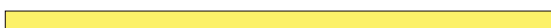

**TIRA VINOLO FOTOLUMINISCENTE**  
0025031 - (TIRA 5cm x 1 metro)



**TIRA VINOLO FOTOLUMINISCENTE FLECHAS**  
0025032 - (TIRA 5cm x 1 metro)



**BOBINA ANTIDESLIZANTE ADHESIVA NEGRA**  
0479036 - (BOBINA 25mm x 18 metros)

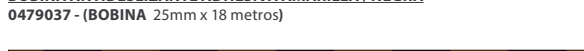

**BOBINA ANTIDESLIZANTE ADHESIVA AMARILLA / NEGRA**  
0479037 - (BOBINA 25mm x 18 metros)



**CINTA ADHESIVA AMARILLA / NEGRA**  
0479028 - (ROLLOS 5cm x 33 metros PACK 6 rollos)



**CINTA ADHESIVA ROJA / BLANCA**  
0479029 - (ROLLOS 5cm x 33 metros PACK 6 rollos)



**CINTA ADHESIVA AMARILLA**  
0479030 - (ROLLOS 5cm x 33 metros PACK 6 rollos)

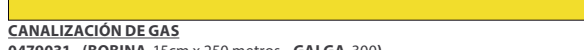

**CANALIZACIÓN DE GAS**  
0479031 - (BOBINA 15cm x 250 metros GALGA 300)



**CANALIZACIÓN DE AGUA**  
0479032 - (BOBINA 15cm x 250 metros GALGA 300)



**CANALIZACIÓN DE ELECTRICIDAD**  
0479033 - (BOBINA 15cm x 250 metros GALGA 300)



**CANALIZACIÓN DE AGUA NO POTABLE**  
0479034 - (BOBINA 15cm x 250 metros GALGA 300)



**CANALIZACIÓN DE AGUA NO POTABLE**  
0479034 - (BOBINA 15cm x 250 metros GALGA 300)



**TELECOMUNICACIONES**  
0479035 - (BOBINA 15cm x 250 metros GALGA 300)



**TELECOMUNICACIONES**  
0479035 - (BOBINA 15cm x 250 metros GALGA 300)



\* Posibilidad de realizar cintas de canalización en bobinas de 100m con cable detector.

## MARÍTIMAS

### M | Formato cuadrado | Sólo pictograma

Señales de seguridad para la localización de dispositivos y medios de salvamento así como el acceso a los mismos en transporte marítimo según la regulación de la OMI. Fabricado en vinilo adhesivo fotoluminiscente. Medidas: 150x150mm.



**M101**  
ABROCHARSE LOS  
CINTURONES



**M102**  
CIERREN PUERTAS



**M103**  
ARRANQUE MOTOR

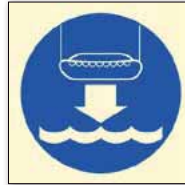

**M104**  
ARRIEN BOTE  
SALVAVIDAS



**M105**  
ARRIEN BALSA  
SALVAVIDAS



**M106**  
ARRIEN BOTE  
DE RESCATE



**M107**  
LARGUEN TIRAS



**M108**  
ABRAN ROCIADORES



**M109**  
ABRAN ALIMENTACIÓN  
DE AIRE



**M110**  
SUELTEN TRINCAS



**M79**  
BOTE SALVAVIDAS



**M81**  
BALSA SALVAVIDAS



**M82**  
BALSA SALVAVIDAS  
ARRIABLE CON PESCANTE



**M83**  
ESCALERA DE  
EMERGENCIA



**M84**  
RAMPA DE EVACUACIÓN



**M85**  
ARO SALVAVIDAS



**M86**  
ARO SALVAVIDAS  
CON RABIZA



**M87**  
ARO SALVAVIDAS  
CON LUZ



**M88**  
ARO SALVAVIDAS CON  
LUZ Y FUMÍGENO



**M89**  
CHALECO SALVAVIDAS



**M90**  
CHALECO SALVAVIDAS  
PARA NIÑOS



**M91**  
TRAJE DE INMERSIÓN



**M92**  
RADIO PORTÁTIL



**M93**  
RADIO BALIZA



**M94**  
RESPONDEDOR  
DE RADAR



**M95**  
BENGALAS DE SOCORRO



**M96**  
BENGALAS EN  
PARACAÍDAS



**M97**  
LANZA CABOS



**M98**  
PUNTO DE REUNIÓN



**M99** (150x75mm)

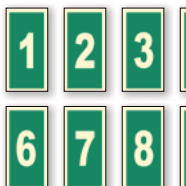

**M100** (75x150mm)

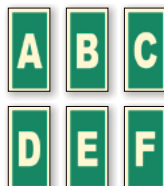

**M111** (75x150mm)



## MARÍTIMAS

**M** | Formato cuadrado | Sólo pictograma

Señales de seguridad para la localización de dispositivos y medios de salvamento así como el acceso a los mismos en transportes marítimos según la regulación de la OMI. Fabricado en vinilo adhesivo fotoluminiscente. Medidas: 150x150mm.



**M001**  
PLAN DE EXTINCIÓN  
DE INCENDIOS

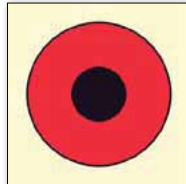

**M002**  
PULSADOR DE  
ALARMA DE FUEGO

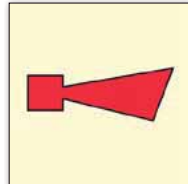

**M003**  
BOCINA DE ALARMA DE  
INCENDIOS

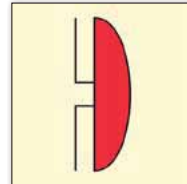

**M004**  
CAMPANA DE ALARMA  
DE INCENDIOS

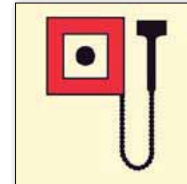

**M005**  
PUNTO  
DE ALARMA MANUAL



**M006**  
ESPACIO PROTEGIDO CON  
ALARMA AUTOMÁTICA  
DE INCENDIOS

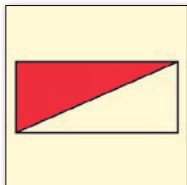

**M007**  
PLAN DE ALARMA  
DE INCENDIO

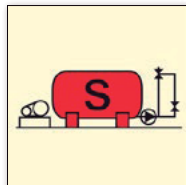

**M008**  
INSTALACIÓN  
DE SPRINKLERS



**M009**  
ESPACIO PROTEGIDO  
POR SPRINKLERS

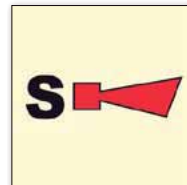

**M010**  
ALARMA  
DE SPRINKLERS

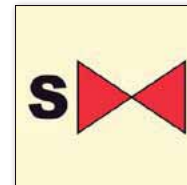

**M011**  
VÁLVULA DE SECCIÓN DE  
SPRINKLERS

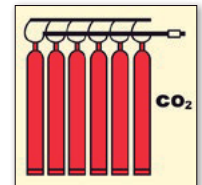

**M012**  
BATERÍA DE CO<sub>2</sub>

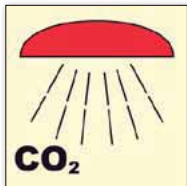

**M013**  
ESPACIO PROTEGIDO  
POR CO<sub>2</sub>

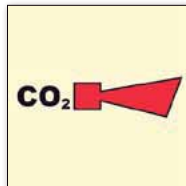

**M014**  
ALARMA DE CO<sub>2</sub>

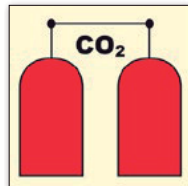

**M015**  
ESTACIÓN DE DESCARGA  
DE CO<sub>2</sub>



**M016**  
BATERÍA DE HALÓN 1301

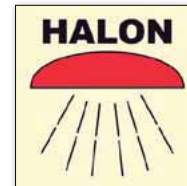

**M017**  
ESPACIO PROTEGIDO  
POR HALÓN 1301

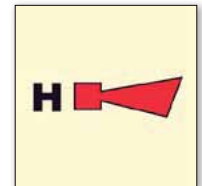

**M018**  
ALARMA DE HALÓN

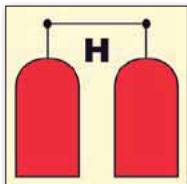

**M019**  
ESTACIÓN DE RECARGA  
DE HALÓN

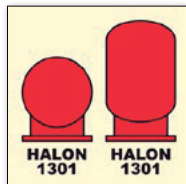

**M020**  
DEPÓSITOS DE HALÓN  
EN ÁREA PROTEGIDA

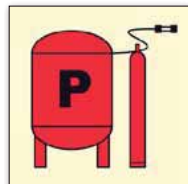

**M021**  
INSTALACIÓN DE POLVO



**M022**  
CAÑÓN DE POLVO

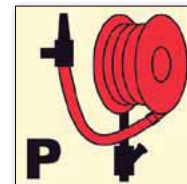

**M023**  
MANGUERA Y  
LANZA DE POLVO

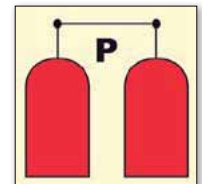

**M024**  
ESTACIÓN DE DESCARGA  
DE POLVO

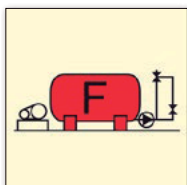

**M025**  
INSTALACIÓN  
DE ESPUMA



**M026**  
CAÑÓN DE ESPUMA

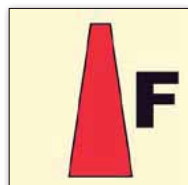

**M027**  
INYECTOR DE ESPUMA

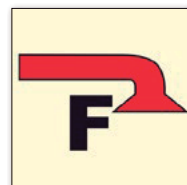

**M028**  
ESPACIO PROTEGIDO  
POR ESPUMA

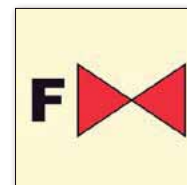

**M029**  
VÁLVULA DE ESPUMA

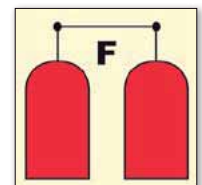

**M030**  
ESTACIÓN DE DESCARGA DE  
ESPUMA

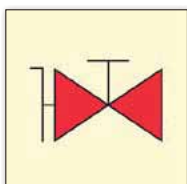

**M031**  
VÁLVULAS DE INCENDIO



**M032**  
CAJA DE MANGUERAS

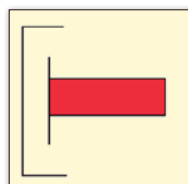

**M033**  
CONEXIÓN LATERAL  
INTERNACIONAL

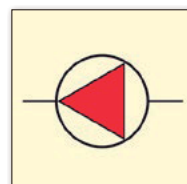

**M034**  
BOMBA DE INCENDIOS

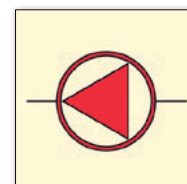

**M035**  
BOMBA DE INCENDIOS  
DE EMERGENCIA

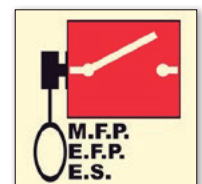

**M036**  
CONTROL REMOTO  
BOMBAS INCENDIO E INTER-  
RUPTOR DE EMERGENCIA

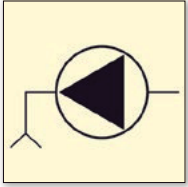

**M037**  
BOMBA DE SENTINA

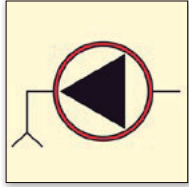

**M038**  
BOMBA DE SENTINA  
DE EMERGENCIA



**M039**  
CAÑÓN DE AGUA



**M040**  
APLICADOR DE NIEBLA  
DE AGUA

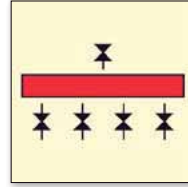

**M041**  
INSTALACIÓN DE EMPAPE

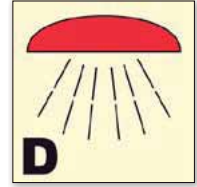

**M042**  
ESPACIO PROTEGIDO  
POR SISTEMA DE EMPAPE

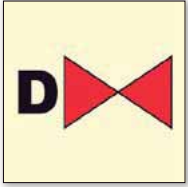

**M043**  
VÁLVULA DE SISTEMA  
DE ESCAPE



**M044**  
ESTACIÓN DE INCENDIOS



**M045**  
ARMARIO CON EQUIPO  
DE BOMBEROS



**M046**  
ARMARIO CON EQUIPO  
DE RESPIRACIÓN



**M047**  
ARMARIO CON ROPA  
PROTECTORA

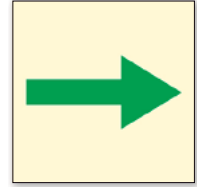

**M048**  
VIA DE EVACUACIÓN  
PRINCIPAL

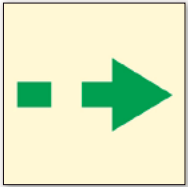

**M049**  
VIA DE EVACUACIÓN  
SECUNDARIA

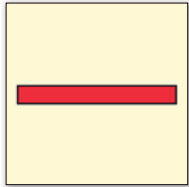

**M050**  
DIVISIÓN CLASE A

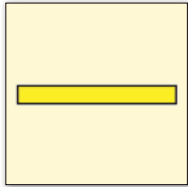

**M051**  
DIVISIÓN CLASE B

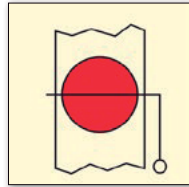

**M052**  
CORTAFUEGOS EN  
RESPIRADERO

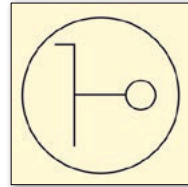

**M053**  
CLARABOYAS CON  
CONTROL REMOTO

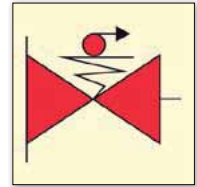

**M054V**  
VÁLVULAS CON  
CONTROL REMOTO  
ACEITE / COMBUSTIBLE



**M055**  
ESTACIÓN DE CONTROL



**M056**  
APLICADOR PORTÁTIL  
DE ESPUMA



**M057**  
INSTALACIÓN DE  
GAS INERTE

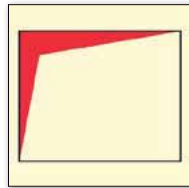

**M058**  
SURTIADOR DE ESPUMA  
DE ALTA EXPANSIÓN

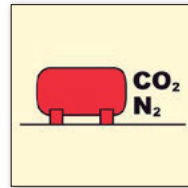

**M059**  
DEPÓSITO DE CO<sub>2</sub> /  
NITRÓGENO



**M060**  
GENERADOR  
DE EMERGENCIA

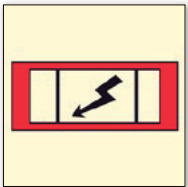

**M061**  
CENTRALITA TELEFÓNICA  
DE EMERGENCIAS

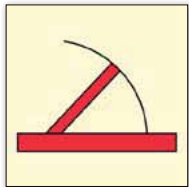

**M062**  
PUERTA DE INCENDIOS  
CLASE A

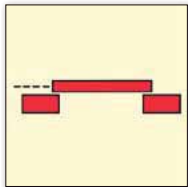

**M063**  
PUERTA DE INCENDIOS  
CORREDERA CLASE A

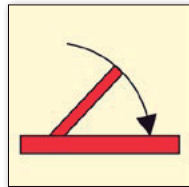

**M064**  
PUERTA DE INCENDIOS  
AUTOCIERRE CLASE A

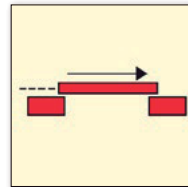

**M065**  
PUERTA DE INCENDIOS  
CORREDERA  
AUTOMÁTICA CLASE A

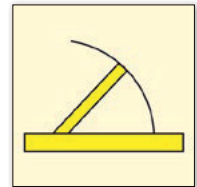

**M066**  
PUERTA DE INCENDIOS  
AUTOCIERRE CLASE B

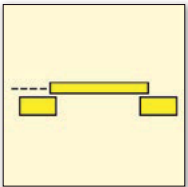

**M067**  
PUERTA DE INCENDIOS  
CORREDERA CLASE B

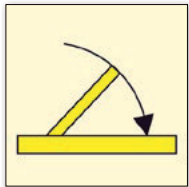

**M068**  
PUERTA DE INCENDIOS  
AUTOCIERRE CLASE B

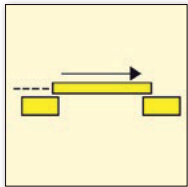

**M069**  
PUERTA DE INCENDIOS  
CORREDERA  
AUTOMÁTICA CLASE B

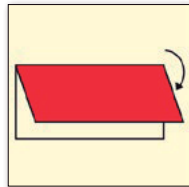

**M070**  
SISTEMA PARA CIERRE DE  
VENTILACIÓN EXTERIOR

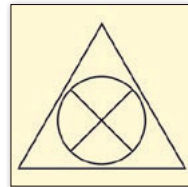

**M071**  
SISTEMA DE CONTROL  
REMOTO DE CIERRE  
DE VENTILACIÓN

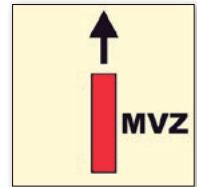

**M072**  
ZONA VERTICAL  
PRINCIPAL

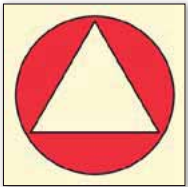

**M073**  
DETECTOR DE GAS



**M074**  
DETECTOR DE LLAMAS

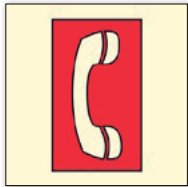

**M075**  
TELÉFONO DE  
EMERGENCIAS

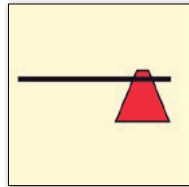

**M076**  
CORTAFUEGO



**M077**  
DETECTOR DE HUMO



**M078**  
DETECTOR DE  
TEMPERATURA



## SEÑALIZACIÓN ESPECIAL PERSONALIZADA

Al ser fabricantes podemos diseñar y fabricar el cartel, la señal o el adhesivo que desee. Además, le ofrecemos la posibilidad de emplear el material o acabado que más se adapte a sus necesidades. Antes de realizar su pedido, consultar cantidades con nuestro departamento comercial.



Ejemplo 01



Ejemplo 02



Ejemplo 03



Ejemplo 04



Ejemplo 05



Ejemplo 06



Ejemplo 07



Ejemplo 08



Ejemplo 09



Ejemplo 10



Ejemplo 11



Ejemplo 12



Ejemplo 13



Ejemplo 14



Ejemplo 15



Ejemplo 16



Ejemplo 17



Ejemplo 18



Ejemplo 19



Ejemplo 20

## PARA ALMACENES Y GRANDES SUPERFICIES

Fabricamos señales en el formato y material que mejor se adapte a sus necesidades. Consúltenos.



### Grippers para señales

Accesorio para la colocación de señales a doble cara con base adhesiva. Ideal tanto para techo como para pared.

Ref: Gripper 10	100mm	1x 
Ref: Gripper 14	140mm	1x 
Ref: Gripper 20	200mm	1x 
Ref: Gripper 28	280mm	1x 





## SEÑALIZACIÓN PARA SUELO

### Vinilo adhesivo + laminador de suelo

Pictogramas de seguridad específicos para suelo. Fabricados en vinilo adhesivo, con laminador antideslizante de alta resistencia. Se aconseja que la superficie esté seca y limpia en el momento de la aplicación.

#### Medidas y materiales

MATERIAL	MEDIDA
Vinilo adhesivo	300x300mm 00800__

 0080030	 0080031	 0080032	 0080033
 0080034	 0080035	 0080036	 0080037
 0080038	 0080039	 0080040	 0080041
 0080042	 0080043	 0080044	 0080045



**POR FAVOR ESPERE SU TURNO**  
TIRA VINILO ADHESIVO+LAMINADOR ANTIDESLIZANTE AZUL/BLANCO 0080050 - (TIRA 10 cm x 1m)

**POR FAVOR ESPERE SU TURNO**  
TIRA VINILO ADHESIVO+LAMINADOR ANTIDESLIZANTE BLANCO/ROJO 0080046 - (TIRA 10cm x 1m)

**POR FAVOR ESPERE SU TURNO**  
TIRA VINILO ADHESIVO+LAMINADOR ANTIDESLIZANTE AMARILLO/NEGRO 0080047 - (TIRA 10cm x 1m)

  
TIRA VINILO ADHESIVO+LAMINADOR ANTIDESLIZANTE BLANCO/ROJO 0080048 - (TIRA 10cm x 1m)

  
TIRA VINILO ADHESIVO+LAMINADOR ANTIDESLIZANTE AMARILLO/NEGRO 0080049 - (TIRA 10cm x 1m)



## SEÑALIZACIÓN PARA SUELO

### PLANTILLAS

Fabricación de plantillas de pictogramas de máscara para señalización, indicación de zonas reservadas, etc... . Simplemente hay que colocar la máscara sobre la zona que se quiere marcar y aplicar pintura sobre ella. Consúltenos los materiales y medidas disponibles.

#### Medidas y materiales

MATERIAL	MEDIDA	500x500mm
Aluminio 0.8mm / PVC		00800__



0080051  
(500x500mm)

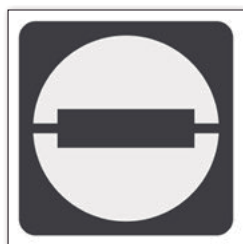

0080052  
(500x500mm)



0080053  
(500x500mm)



0080054  
(500x500mm)



0080055  
(500x500mm)  
(900x700mm)





## MARCOS ABS PARA SEÑALES (ANTIVANDÁLICOS)

Mediante una sencilla instalación, los marcos ABS mejoran la estética de sus señales a la vez que prolongan la duración de estas. Las señales además, estarán protegidas contra actos vandálicos. Disponibles en varios colores y tamaños.



00800303



00800305



00800301

Ref: 00800301	A4 (210x297mm)		1x
Ref: 00800302	A5 (148x297mm)		1x
Ref: 00800303	250x62mm		1x
Ref: 00800304	175x45mm		1x
Ref: 00800305	148x148mm		1x
Ref: 00800306	62x62mm		1x

## MARCOS INYECTADOS

Le ofrecemos la posibilidad de inyectar un marco de plástico alrededor de la señal para conseguir más seguridad al manipularla y mejorar su seguridad. Colores personalizados. Consúltenos.



## MARCOS EN ALUMINIO

Protegen la señal, así como le dan un acabado de calidad. Podemos fabricarlas a medida para personalizar sus marcos. Consúltenos.



Ref: 00800311	A3 (297x420mm)	1x
Ref: 00800312	A4 (210x297mm)	1x

## MARCOCLICK "SERENA"

Marcos a pared fabricados en aluminio anodizado con moldura extrusionada de gran resistencia. Incluye plástico antirreflectante en su parte frontal para una correcta conservación de la gráfica. Fácil cambio de gráficas gracias a su sistema de apertura "click". Se suministra con colgadores.



Ref: 10404	A3 (297x420mm)	1x
Ref: 10405	A4 (210x297mm)	1x



## MARCOCLICK "TRUJILLO"

Marcos a pared fabricados en aluminio anodizado con moldura extrusionada de gran resistencia. Incluye colgadores y plástico antirreflectante para una correcta conservación de la gráfica. Fácil cambio de gráficas gracias a su sistema de apertura "click". Más colores bajo pedido.



Ref: 10131	A3 (468x344x20mm)		1x
Ref: 10132	A2 (641x468x20mm)		1x
Ref: 10133	A1 (888x641x20mm)		1x
Ref: 10134	A0 (1236x888x20mm)		1x
Ref: 10135	500x700 (747x547x20mm)		1x
Ref: 10136	700x1000 (1047x747x20mm)		1x





## POSTE SEPARADOR CON CINTA EXTENSIBLE ESTÁNDAR

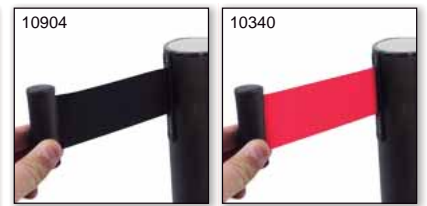
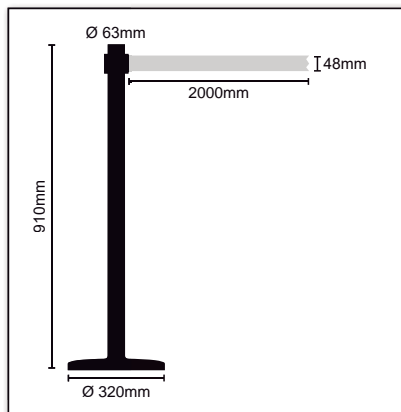

Sistema de bloqueo



Poste separador estandarizado de acero con cinta extensible retráctil de 2 metros y base entallada. La cinta está equipada con un dispositivo de seguridad para evitar que salga del enganche del poste. Diámetro del tubo: 63mm. Peso pack: 17kg.

Ref: 10335	Ø 320x910mm	Poste:	Cinta:	17Kg	2x	Ref: 10421	Ø 320x910mm	Poste:	Cinta:	17Kg	2x
Ref: 10331	Ø 320x910mm	Poste:	Cinta:	17Kg	2x	Ref: 10904	Ø 320x910mm	Poste:	Cinta:	17Kg	2x
Ref: 10336	Ø 320x910mm	Poste:	Cinta:	17Kg	2x	Ref: 10340	Ø 320x910mm	Poste:	Cinta:	17Kg	2x
Ref: 10330	Ø 320x910mm	Poste:	Cinta:	17Kg	2x	Ref: 10420	Ø 320x910mm	Poste:	Cinta:	17Kg	2x

## POSTE SEPARADOR CON CINTA EXTENSIBLE



Poste separador de acero con cinta extensible retráctil de 2 metros y base entallada. La cinta está equipada con un dispositivo de seguridad para evitar que salga del enganche del poste. Diámetro del tubo: 63mm.

Ref: 13706	Ø 320x910mm	Poste:	Cinta:	2x
Ref: 13705	Ø 320x910mm	Poste:	Cinta:	2x

Ref: 10903	Ø 320x910mm	Poste:	Cinta:	2x
Ref: 10905	Ø 320x910mm	Poste:	Cinta:	2x

## POSTE SEPARADOR CON CINTA EXTENSIBLE PERSONALIZABLE

COLORES DE CINTA A ELEGIR:



Poste de acero con cinta extensible retráctil de 2.1 metros y base entallada. Con dispositivo de seguridad para evitar que la cinta se desenganche. Diámetro del tubo: Ø 70mm. Peso: 10 kg.

Ref: 0080001	Ø 350x950mm		1x
--------------	-------------	--	----



\* Consúltenos más colores, textos o logotipos.



## POSTE SEPARADOR APILABLE CON CINTA RETRÁCTIL **NUEVO**



Poste separador de Ø63mm fabricado en acero, base de Ø350mm y cinta retráctil negra de 2m. Disponible en acabados plata o negro.

Ref: 10121    Ø 350x910mm    Poste: ■    Cinta: ■    2x

Ref: 10118    Ø 350x910mm    Poste: ▨    Cinta: ■    2x



## POSTE SEPARADOR CON CINTA RETRÁCTIL Y BASE RODANTE **NUEVO**

1. inclina el poste suavemente hacia ti
2. con la ayuda del pie, desplaza la base
3. fácil de transportar gracias a su base rodante



Poste separador de Ø63mm con base rodante para un fácil y rápido transporte. Incluye cinta retráctil negra de 2 m. Ideal para zonas de mucho tránsito como halls, centros comerciales o aeropuertos. Disponible en 2 acabados, plateado y negro.

Ref: 10930    Ø 360x910mm    Poste: ■    Cinta: ■    2x

Ref: 10929    Ø 360x910mm    Poste: ▨    Cinta: ■    2x

Base rodante para su fácil y rápido transporte



## MINI POSTE SEPARADOR CON CINTA RETRÁCTIL **NUEVO**



Poste separador de pequeñas dimensiones de Ø63mm de poste y 500mm de altura, fabricado en acero, con base de cemento de Ø320mm y cinta retráctil negra de 2m. Disponible en acabados plata o negro.

Ref: 10370    Ø 320x500mm    Poste: ▨    Cinta: ■    2x

Ref: 10371    Ø 320x500mm    Poste: ■    Cinta: ■    2x

## MARCO INFORMATIVO



Disponible en dos acabados: plateado y dorado.

Ref: 10916    380x265mm    Ø 63 mm    ▨    1x

Ref: 10917    380x265mm    Ø 63 mm    ■    1x

## POSTE PARA CORDÓN



Fabricado en acero con tubo liso y base entallada. Acabado en pulido cromado o dorado. Posibilidad de elegir entre parte superior con bola o sin ella. Tubo de 50mm de diámetro.

Ref: 10908	Ø 320x910mm	Sencillo		2x
Ref: 10909	Ø 320x910mm	Sencillo		2x
Ref: 10910	Ø 320x1000mm	Bola		2x
Ref: 10911	Ø 320x1000mm	Bola		2x



## POSTE SEPARADOR TULIP EXCELSIOR



Poste de Ø50mm con elegante diseño, está compuesto por un poste de 915mm de altura y base de Ø320mm de cemento que le proporciona gran estabilidad. Posibilidad de colocación del cordón en 4 posiciones diferentes.

Ref: 10207	Ø 320x915mm	Sencillo		2x
------------	-------------	----------	--	----



## POSTE PARA CORDÓN CON MARCO



Fabricado en acero con tubo liso y base entallada. Acabado en pulido cromado o dorado. Marco superior de 420x320mm, a elegir entre formato vertical y horizontal.

Ref: 10912	Ø 320x1440mm	Vert.: 320x420mm		2x
Ref: 10913	Ø 320x1440mm	Vert.: 320x420mm		2x
Ref: 10914	Ø 320x1300mm	Hor.: 420x320mm		2x
Ref: 10915	Ø 320x1300mm	Hor.: 420x320mm		2x





## ANILLO CROMADO DE Ø 100mm



montaje rápido y sencillo



anillo: Ø 100mm

Complemento ideal conseguir 4 puntos de anclaje en los postes de cordón. Montaje sencillo y acabado cromado.

Ref: 10991

Ø 100mm

1x

COLGADOR A PARED PARA CORDONES **NUEVO**

**NUEVO**



Colgador apto para su colocación en paredes. Disponible en dos acabados: plateado y dorado. Uso habitual en aeropuertos, salas de espera, restaurantes y otras zonas de alto tránsito.

Ref: 13446

40x50x37mm

1x

Ref: 13447

40x50x37mm

1x

## BARRA CROMADA DE 1200mm



ejemplo con gráfica (no incluida)



tubo: Ø 20mm

acero inoxidable



Accesorio para los postes de cordón que permite delimitar espacios de forma temporal, dando a la vez un toque de calidad. Apto para exponer gráficas.

Ref: 10990

1200mm

Tubo Ø 20 mm

1x



## CORDONES PARA POSTES

Cordón de 1500mm con terminación en gancho. Disponible en varios colores y acabados: liso y trenzado.



### ACABADO ATERCIOPELADO + GANCHO PLATEADO

Ref: 10919	1500mm	Cordón liso: <span style="color: red;">■</span>	Enganche:  1x
Ref: 10920	1500mm	Cordón liso: <span style="color: black;">■</span>	Enganche:  1x
Ref: 13760	1500mm	Cordón liso: <span style="color: blue;">■</span>	Enganche:  1x



### ACABADO ATERCIOPELADO + GANCHO DORADO

Ref: 10921	1500mm	Cordón liso: <span style="color: red;">■</span>	Enganche:  1x
Ref: 10922	1500mm	Cordón liso: <span style="color: black;">■</span>	Enganche:  1x
Ref: 13761	1500mm	Cordón liso: <span style="color: blue;">■</span>	Enganche:  1x



### ACABADO TRENZADO + GANCHO PLATEADO

Ref: 10923	1500mm	Cordón trenzado: <span style="color: blue;">■</span>	Enganche:  1x
Ref: 10977	1500mm	Cordón trenzado: <span style="color: white;">■</span>	Enganche:  1x
Ref: 13762	1500mm	Cordón trenzado: <span style="color: red;">■</span>	Enganche:  1x
Ref: 13764	1500mm	Cordón trenzado: <span style="color: black;">■</span>	Enganche:  1x
Ref: 13766	1500mm	Cordón trenzado: <span style="color: red;">■</span>	Enganche:  1x



### ACABADO TRENZADO + GANCHO DORADO













Ref: 10925	1500mm	Cordón trenzado: <span style="color: blue;">■</span>	Enganche:  1x
Ref: 10976	1500mm	Cordón trenzado: <span style="color: white;">■</span>	Enganche:  1x
Ref: 10924	1500mm	Cordón trenzado: <span style="color: red;">■</span>	Enganche:  1x
Ref: 13763	1500mm	Cordón trenzado: <span style="color: black;">■</span>	Enganche:  1x
Ref: 13765	1500mm	Cordón trenzado: <span style="color: red;">■</span>	Enganche:  1x



## SOPORTES DE PARED

### SOPORTE DE PARED PLÁSTICO ESTÁNDAR

Fabricado en plástico. Con diferentes combinaciones de color de soporte y de cinta extensible de 2m de longitud.









Ref:	13700	2m	75x138x80mm	Soporte:		Cinta:		1x 
Ref:	13701	2m	75x138x80mm	Soporte:		Cinta:		1x 
Ref:	13702	2m	75x138x80mm	Soporte:		Cinta:		1x 
Ref:	13703	2m	75x138x80mm	Soporte:		Cinta:		1x 
Ref:	13704	2m	75x138x80mm	Soporte:		Cinta:		1x 

\* receptor de cinta a pared incluido



### SOPORTE DE PARED PLÁSTICO XL





Fabricado en plástico color amarillo y negro. Disponible en 3 longitudes de cinta, en color cebreado amarillo y negro.

Ref:	13767	3m	120x170x95mm	Soporte:		Cinta:		1x 
Ref:	13768	5m	120x170x95mm	Soporte:		Cinta:		1x 
Ref:	13769	10m	120x170x95mm	Soporte:		Cinta:		1x 



### SOPORTE DE PARED METÁLICO CON CINTA RETRÁCTIL ESTÁNDAR

Soporte fabricado en acero lacado negro o cromado, con anclaje a pared, cinta retráctil en color negro de 2m de longitud y 2 receptores de cinta laterales.



Ref:	10918	Alt.: 130mm	Ø 63 mm	0.7 kg		1x 
Ref:	10975	Alt.: 130mm	Ø 63 mm	0.7 kg		1x 

\* receptor de cinta a pared incluido



### SOPORTE A PARED CON CINTA PERSONALIZABLE

Soporte fabricado en acero lacado negro, con anclaje a pared y cinta extensible negra de 2m de longitud. Indique el color de la cinta en su pedido.



Ref:	0080004	Alt.: 130mm	Ø 63 mm	0.6 kg		1x 
------	---------	-------------	---------	--------	---	--

\* receptor de cinta a pared incluido



### RECEPTORES DE CINTA A PARED

Apto para conectar el sistema de cinta retráctil a pared. Incluye tornillería.

Ref:	10918P	Alt.: 87mm		1x 
------	--------	------------	---	--



## POSTES PLASTICOS

### POSTE SEPARADOR CON BASE DE PLÁSTICO RELLENABLE



Este poste separador de 910mm, disponible en rojo y amarillo, con base de plástico rellenable y cinta plegable de 2.1m, con sistema de bloqueo. Fácil de montar y desmontar para su almacenaje y transporte. Ideal para almacenes, fábricas, construcciones, aeropuertos, etc.

Ref: 80304YE	Ø 320x910mm	Poste:	Cinta:	6x
Ref: 80304RD	Ø 320x910mm	Poste:	Cinta:	6x

### POSTE DE BASE RELLENABLE



Poste de base plástica rellenable negra. Disponible en 2 colores: rojo y amarillo. Apto para combinar su uso con una cadena.

Ref: 80303YE	Altura: 1000mm	Poste:	1x
Ref: 80303RD	Altura: 1000mm	Poste:	1x

### POSTE



Cuerpo de polietileno y base de caucho de 6 kg. Válido para el empleo de cadena o cinta de balizamiento.

Ref: 80301	Altura: 1100mm	7.00 kg	1x
------------	----------------	---------	----

### POSTE FLEXIBLE



\* Disponible accesorio de señalización. (ver pag. 106)

3 Bandas reflectantes

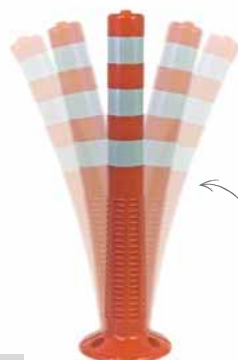

Poste flexible fabricado en poliuretano con 3 bandas reflectantes.

Ref: 80302	Altura: 750mm	1.15 Kg	1x
------------	---------------	---------	----

### POSTE ARTICULADO



Poste/baliza articulado al impacto, recupera su forma de manera inmediata. Cuenta con banda reflectante y anilla superior.

Ref: 80305	Altura: 800mm	2.60 Kg	1x
------------	---------------	---------	----



## POSTES LIGEROS

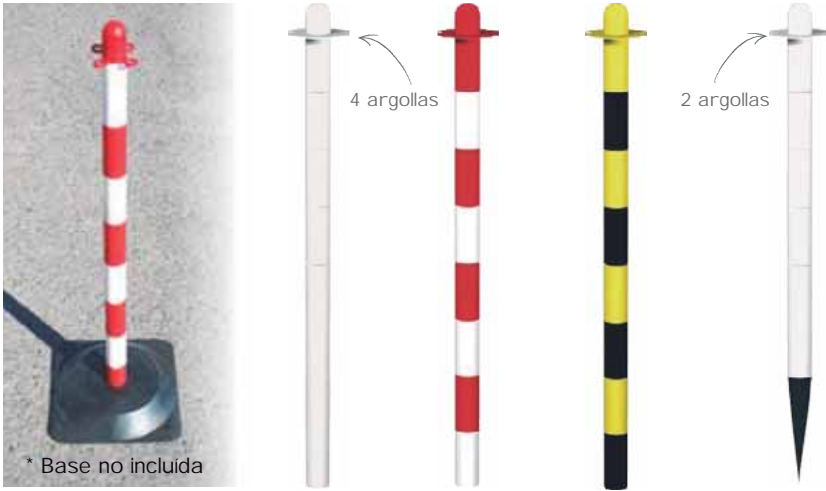

\* Base no incluida

Postes ligeros fabricados en polietileno, cuentan con caperuzas superiores de 4 argollas para conectar la cadena. El diámetro de la parte superior es de Ø 30mm y en la parte inferior de Ø 50mm. Excepto la referencia 0489004 que cuenta con caperuzas superiores de 2 argollas, con Ø 40mm de diámetro superior y un remate inferior de pico de 270mm en nylon resistente diseñado para clavar en el suelo.

Ref: 0489001	900mm	0.25 Kg	<input type="checkbox"/>	1x
Ref: 0489002	900mm	0.25 Kg	<input checked="" type="checkbox"/> <input type="checkbox"/>	1x
Ref: 0489003	900mm	0.25 Kg	<input checked="" type="checkbox"/> <input type="checkbox"/>	1x
Ref: 0489004	800mm	0.30 Kg	<input type="checkbox"/>	1x

## BASES PARA POSTES



Disponibles dos tipos de base, cuadrada de goma más pesada o redonda de plástico con un peso de 0.30 kg vacía que ofrece la posibilidad de rellenarla de 4 litros de agua o arena.

Ref: 0489005	270x270mm	Goma	1.40 Kg	1x
Ref: 0489006	Ø 300mm	Plástico	0.30 Kg	1x

## CADENAS DE PLÁSTICO



Se fabrican en polietileno y sin metales pesados según la normativa europea. Lavables y resistentes a la intemperie, a la sal, a productos químicos y a temperaturas de entre -10° y 75°.

Ref: 04890008	Ø 8mm	25 metros	<input checked="" type="checkbox"/> <input type="checkbox"/>	1x
Ref: 04890009	Ø 8mm	25 metros	<input checked="" type="checkbox"/> <input type="checkbox"/>	1x
Ref: 04890010	Ø 8mm	25 metros	<input type="checkbox"/>	1x
Ref: 04890011	Ø 5mm	25 metros	<input checked="" type="checkbox"/> <input type="checkbox"/>	1x
Ref: 04890012	Ø 5mm	25 metros	<input checked="" type="checkbox"/> <input type="checkbox"/>	1x
Ref: 04890013	160x20mm	0.015 Kg	<input type="checkbox"/>	1x

## CONECTORES DE CADENAS



Dos diámetros de anilla.

Ref: 0489014	Ø 8mm	25x
Ref: 0489015	Ø 5mm	25x

## MARCO PARA POSTE



\* Poste y base no incluido

Sistema de marco portagráfica tamaño A4 para colocar sobre poste. Ideal para emplearlo en obras o accesos a modo de señalética. Fácil cambio de gráfica.

Ref: 620001	A4	1x
-------------	----	----

## CONO **NUEVO**



Fabricado en una sola pieza



Cono fabricado en polietileno, con banda reflectante de 110mm.

Ref: 4761002    300x220x220mm    0.25Kg    10x

## CONO FLEXIBLE CON BASE DE CAUCHO



Retorna a su estado original



Cono flexible, con base de caucho. Incluye 2 bandas reflectantes.

Ref: 80514    280x500mm    2.0Kg    10x

## CONOS CON BASE DE CAUCHO



\* Disponible accesorio de señalización. ref: 80519 + ref: 80520



Cono con banda reflectante, fabricado en polietileno con base de caucho.

Ref: 80511    Alt:1000mm    Base:490mm    5Kg    1x

Ref: 80512    Alt:750mm    Base:380mm    2.5Kg    1x

Ref: 80513    Alt:500mm    Base:280mm    1.5Kg    1x



## CONOS PLEGABLES DE NYLON

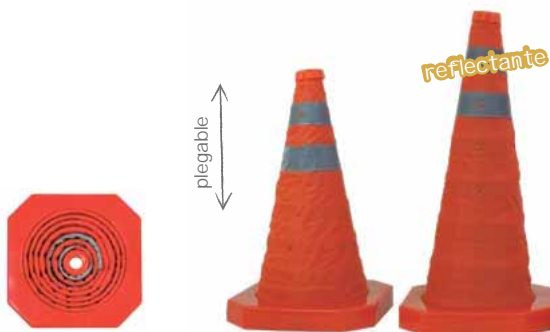

Cono plegable con 2 bandas reflectantes. Fabricado en nylon con base de ABS. Disponible en 3 tamaños diferentes.

Ref: 80503    Alt:700mm    Base:340mm    0.95Kg    1x

Ref: 80502    Alt:500mm    Base:243mm    0.55Kg    1x

Ref: 80501    Alt:400mm    Base:243mm    0.55Kg    1x

## CONO PLEGABLE DE NYLON CON BASE DE CAUCHO **NUEVO**



Luz interna intermitente o fija



Posibilidad de acloplar luz externa ref: 80504 (no incluido).



Bolsa de transporte

Cono fabricado en nylon con base de caucho. Gracias a su diseño plegable permite ahorrar espacio. Incluye luz interna para mejorar su visibilidad nocturna.

Ref: 80505    Alt:500mm    Base:280mm    1.95Kg    1x



## BALIZA PARA CONO

Apta para la mayoría de conos. Lente de color naranja, con 6 Leds y más de 60 destellos por minuto, lo que le hace visible a más de 200m. Requiere 2 pilas "D" LR20 - 1.5 V (no incluidas). Cuenta con 200h de autonomía continua. Encendido y apagado automático gracias a una célula fotoeléctrica. Dispone de asa de plástico para su transporte.



Ref: 80706 490mm Ø 180mm 0.55 Kg ■ 1x

## CAMISA PARA CONO



Incluye 14 Leds. 3 modos de destello intermitente: normal, rápido y fijo. Funciona con 3 pilas AA (no incluidas).

Ref: 80708 14 Leds 3 Modos de destello ■ ■ 1x

## CINTA EXTENSIBLE PARA CONO DE 1 M



Cinta extensible de 3m de longitud y 50mm de ancho. Diseñada para ajustar en la mayoría de conos de más de 3kg.

Ref: 80516 3m 0.25 Kg 1x

## LUZ PARA CONO PLEGABLE



Accesorio para facilitar la visibilidad por la noche. Se suministra sin pilas.

Ref: 80504 Ø 20m 1x

## TAPÓN PARA POSTES



Con 4 argollas para cadena. También apto para insertar en la parte superior de los conos.

Ref: 0489024 Ø 20m 1x

## CONECTOR DE CADENA PARA CONO



Cuenta con dos conexiones para cadena. Ideal para cadenas de 5 a 8mm.

Ref: 80517 Ø80mm Ø90mm 0.05 Kg ■ 1x

## CADENA PARA CONO



Cadena roja y blanca de 6mm y de 2m de longitud para colocar sobre cono.

Ref: 80518 Long.: 2000mm 0.20 Kg ■ ■ 1x

## RECTÁNGULO REFLECTANTE



Rectángulo reflectante con gancho para colgar y reflector de Ø 60mm.

Ref: 0489016 140x105mm 1x

## PANEL PARA CONO / POSTE ▲ NUEVO

Panel para señales DIN A4 (297x210mm) fabricado en polipropileno celular de 5mm para colocación en conos o postes con las diferentes conexiones que disponemos. Puede usarse con las diferentes señales adhesivas. Solución perfecta para emplear señales de manera temporal.

Ref: 80519	Altura: 700mm	Gráfica: A4	0.20Kg	<span style="color: red;">■</span>	1x
Ref: 80520	Soporte para Cono	Ø 80x140mm	0.05Kg	<span style="color: red;">■</span>	1x
Ref: 80306	Soporte para Poste	Ø 85x75mm	0.05Kg	<span style="color: red;">■</span>	1x



80519

80520

80306

## CONO CUATRO CARAS



Personalizable con su propio texto y pictograma

Fabricado en polipropileno. Disponible con o sin serigrafía.

Ref: 80603	670x280x280mm	1.1 Kg		1x
Ref: 80604	670x280x280mm	1.1 Kg		1x

## CONO PORTAGRÁFICA "CHARLEROI"



Fácil cambio de señal

Tamaño de gráfica: 330x382mm

Base rellenable de 4 litros de agua o arena.

Doble cara

Banner de exterior ideal para uso en entradas de tiendas, jardines, aceras, etc. Doble cara. Base rellenable de agua o arena.

Ref: 10248	1200x330x382mm	2.0 Kg		1x
------------	----------------	--------	--	----

## CABALLETES DE SEÑALIZACIÓN PLEGABLES



ASS01

80601

80602

Personalizable

CABALLETE DE PVC DE 3mm PARA SEÑALES A4: Perfecto para indicar un riesgo de forma temporal. Ofrece la posibilidad de colocar cualquier señal de vinilo adhesivo.

CABALLETES DE POLIETILENO: De fácil almacenamiento. Ideal para la indicación clara de peligros y avisos.

Ref: ASS01	465x380x325mm	0.65 Kg	PVC		1x
Ref: 80601	620x250x300mm	0.6 Kg	Polietileno		1x
Ref: 80602	620x250x300mm	0.6 Kg	Polietileno		1x



## CABALLETE "DELTA"



Caballete a doble cara con posibilidad de insertar gráfica intercambiable (no incluida). Medida de gráfica: 745x550mm

Ref: 10679      7.0 Kg      ■      1x

## CABALLETE "DOVER"



Ref.: 13.129



Ref.: 13.131

Ref.: 13.130

Caballete doble cara fabricado en PVC.

Ref: 13129	Tamaño de gráfica 480x715mm	1x
Ref: 13130	Tamaño de gráfica 480x815mm	1x
Ref: 13131	Pizarra      Tamaño de gráfica 480x815mm	1x

## CABALLETE EXTERIOR CON ESTRUCTURA DE ACERO

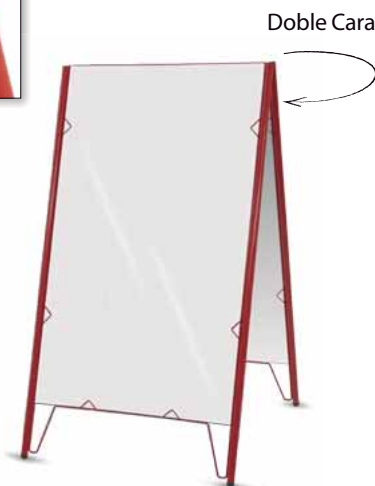

\*Panel blanco (10.168) de venta a parte



Caballete doble cara fabricado en acero para uso en exterior. Disponible en seis colores diferentes.



Ref: 10167	600x1000mm		1x
Ref: 10168	Panel blanco - 590x995mm		1x

## CABALLETE MARCOCLIP "MERIDA"



Colores disponibles bajo pedido.

- Color Madera
- Ral 5005
- Ral 3020
- Ral 6029

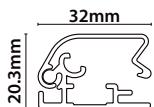

Marcos sobre caballete, fabricados en aluminio anodizado con moldura extrusionada de gran resistencia. Incluye plástico antirreflectante para una mejor conservación de la gráfica. Adecuado para uso interior o exterior. Fácil intercambio de gráfica gracias a su sistema de apertura "click".

Doble Cara



Disponible en 3 tamaños

Ref: 10337	A1 (1400x638x698mm)	■	1x
Ref: 10119N	A1 (1400x638x698mm)	■	1x
Ref: 10338	500x700 (1050x544x598mm)	■	1x
Ref: 10122N	500x700 (1050x544x598mm)	■	1x
Ref: 10339	700x1000 (1400x744x799mm)	■	1x
Ref: 10124N	700x1000 (1400x744x799mm)	■	1x

## PIZARRA EN CABALLETE DE MADERA

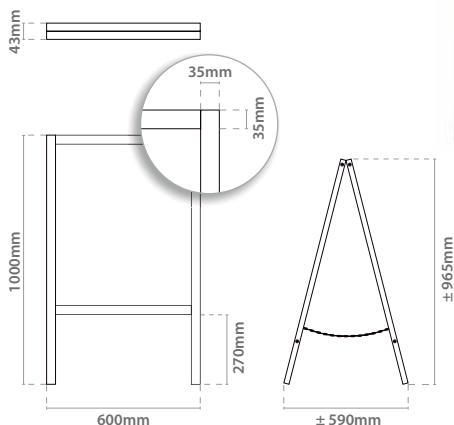

Con cadena de detención



Pizarra tipo A de doble cara en caballete de madera plegable. Perfil del marco: 35mm. Apto para usar con tizas (no incluidas).

Ref: 14104	Plegada: 600x43x1000mm	1x
------------	------------------------	----



## VALLA EXTENSIBLE 3000mm CON RUEDAS



Fabricada en acero, malla de aluminio y patas de plástico. Con 4 ruedas acoplables con freno. En rojo/blanco o amarillo/negro.

Ref: 80204	Alt.: 950mm	Plegada: 250mm	6.0 Kg		1x
Ref: 80205	Alt.: 950mm	Plegada: 250mm	6.0 Kg		1x

Anclajes laterales para conectar a otras vallas



Ruedas con freno acoplables

## VALLA EXTENSIBLE CUADRADA



Ideal para cercar espacios en obras



Fabricada en hierro y pintada en rojo/blanco.  
Plegada: 1000x140x140mm | Extendida: 1000x1500x1500mm

Ref: 80202	Alt.: 1000mm	12.45 Kg		1x
------------	--------------	----------	--	----

## VALLA EXTENSIBLE RECTA



Fabricada en hierro y pintada en rojo/blanco.  
Plegada: 1100x250mm | Extendida: 1100x3000mm

Ref: 80201	Alt.: 1100mm	9.10 Kg		1x
------------	--------------	---------	--	----

## VALLA "MANAUS"

Ideal para formar barreras con gráfica personalizable



Fabricado en aluminio para gráfica a doble cara textil.

Ref: 10791	400x920x2025mm	5.0 Kg		1x
------------	----------------	--------	--	----

## VALLA "LIFFORD"



Ideal para emplearse junto a otra valla Lifford

Valla fabricada en acero lacado galvanizado para gráfica a doble cara con protector antireflex magnético incluido.

Ref: 10701	505x872x1200mm	15.7 Kg		1x
------------	----------------	---------	--	----

## BARRERA RELLENABLE DE AGUA



Conector disponible bajo pedido  
Ref: 80.210

Barreras apilables rellenebles de agua, están fabricadas en polietileno resistente a los rayos UV, se puede aplicar para trabajos temporales de control de carreteras o división del tráfico. Diseño apilable de fácil almacenamiento y transporte. Gracias al conector se puede ajustar y colocar las barreras formando diferentes formas.

Ref: 80209    620x365x925mm    6.0 Kg       2x

## BARRERA DE SEGURIDAD CON RUEDAS

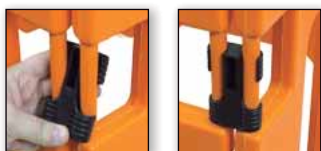

Ideal para cercar obras



Con ruedas laterales

Barrera multifunción de estructura modular. Con banda reflectante y espacio para una señal a ambos lados de la barrera. Con ruedas laterales.

Ref: 80208    1100 (1 barrera)x870x30mm    18.0 Kg       1x

## BARRERA DE SEGURIDAD ENLAZABLE



Ideal para barreras



Con conexiones laterales

Barrera de seguridad de 1.1m o 2m de ancho. Con sistema de anclaje lateral. Con banda reflectante central y patas giratorias para un mejor almacenaje. Cuenta con la posibilidad de situar una señal a doble cara.

Ref: 80206    1100x1020x50mm    8.95 Kg       1x

Ref: 80207    2000x1020x50mm    13.0 Kg       1x

Patas giratorias para un mejor almacenaje

## VALLA EXTENSIBLE



Luces frontal y superior incluidas

Fabricada en polietileno, con 52 franjas reflectantes. Tiene 2 asas de transporte, sistema de bloqueo y cierres de seguridad. Bases rellenebles con agua o arena. Incluye 2 luces.

Ref: 80203    1100x475x135mm    6.2 Kg    Extensión Max. 2250mm    1x



MAX. 2250mm



## BANNER EXTENSIBLE "VILAMOURA"



Ideal como elemento informativo

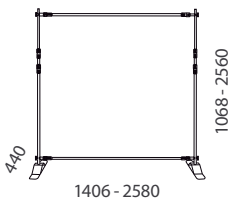

Fabricado en acero lacado negro. Diseñado con tubos telescópicos lo que le permite el uso de gráficos de diferentes anchos y alturas.

- Área gráfica mínima: ± 860mm alto x 1270mm ancho.
- Área gráfica máxima: ± 2350mm alto x 2445mm ancho.

Ref: 10498 max.: 2580x440x2560mm 8.0 Kg 1x

## BASTÓN LUMINOSO ROJO



Bastón de señalización luminoso de color rojo con tecnología LED, cuenta con 3 posiciones: luz intermitente, luz fija y apagado. Ideal para operaciones en aeropuertos, retenes y desviaciones en carretera. Viene con correa de sujeción.

Ref: 80704 Ø40X540mm 1x

## PLACA REFLECTANTE



Placa de alta reflectancia a bandas rojas y blancas. Ideal para la señalización de las mercancías que exceden los límites del vehículo.

Ref: 00530001 500X500mm 1x

## PALETA LUMINOSA LED



Paleta reflectante y luminosa con 6 LEDs rojos y 6 LEDs verdes. 4 posiciones: luz intermitente roja, luz fija roja, luz fija verde y apagado. Incluye correa de mano. Requiere pilas "C" LR14 - 1,5V (no incluidas).

Ref: 80705 Ø 180x410mm Doble cara 1x

## PALETA DE STOP-PASO



Paleta de señalización vial. Con señal de "stop" por una cara y señal de "paso" en el reverso. Esta paleta es ideal para regular el paso en zonas de gran afluencia de tráfico como obras o centros comerciales.

Ref: 0080011 Doble cara 1x

## LÁMPARA LED PORTÁTIL **NUEVO**



Incluye soporte para ajuste direccional



58477 | 10W

58478 | 20W

58479 | 30W

58480 | 50W

Lámpara-proyector portátil de exterior IP44 con LED SMD extra blanca 6000~6500K. Disponibles 4 potencias: 10W, 20W, 30W y 50W. Cuenta con una batería recargable por toma de corriente AC110-240V o mediante adaptador para coche de DC12-24V (ambos incluidos). Tiempo de recarga: 6-12 horas aprox. Incluye soporte para ajuste direccional del haz de luz. Bajo consumo energético y un alto rendimiento, ideal para la iluminación de obras, campings, actividades de caza, pesca, estudios fotográficos o incluso como luz de emergencia para el coche y el hogar.

Ref: 58477	10W	165x255x145mm	1	1x
Ref: 58478	20W	185x290x215mm	2	1x
Ref: 58479	30W	225x335x275mm	4	1x
Ref: 58480	50W	225x335x275mm	8	1x



## TRÍPODE TELESCÓPICO



**NUEVO**

Apto para el empleo de 1 o 2 dispositivos de luz

Trípode telescópico portátil para exterior compuesto por tres tramos verticales estables, extra largos y que proporcionan una altura regulable de 630mm a 1660mm. Tuercas de regulación manejables y seguras para los tramos. Incluye soporte superior de 498mm para el empleo de hasta 2 dispositivos de luz. Color amarillo. Ideal para ser empleado junto a las lámparas de proyección LED en iluminación de construcción, comercial, de jardín o de estudio.



\* Lámparas LED no incluidas



Ref: 58481 Plegado: 590x95mm | Altura 630mm - 1660mm 1x

## BALIZAS INTERMITENTES

**NUEVO**

Baliza intermitente de 2 LEDs, lente de color amarilla o naranja y base color amarilla, funciona con 1 o 2 baterías 4R25 de 6 voltios (no incluidas), con cabeza giratoria de 90° de 180mm de diámetro para una máxima luminosidad, lente estándar con un sistema óptico muy avanzado, célula fotoeléctrica incorporada, encendido y apagado automático (detector de luz) flash estándar de 65-75 por minuto, luz intermitente y fija. Asa metálica, anclaje trasero para colgar en vallas, conos y otros elementos. Llaves incluidas. CON CERTIFICADO CE.



80709

80710

Ref: 80709	2 LEDS	180x80x350mm		12x
Ref: 80710	2 LEDS	180x80x350mm		12x



## ESPEJO EXTERIOR



Lente fabricada en policarbonato y trasera en polipropileno. Ángulo de visión ajustable de 130°. Alta resistencia al impacto. Incluye tornillos y anclaje para tubo. Para tubos de diámetro mín. de 50mm en el espejo de 600mm y 70mm en el de 800mm.

Ref:	80105	Ø 975mm	8.2 Kg	780x1000x150mm	1x	
Ref:	80101	Ø 800mm	6.55 Kg	850x860x140mm	1x	
Ref:	80121	Ø 600mm	3.5 Kg	620x630x110mm	1x	



## ESPEJO INTERIOR

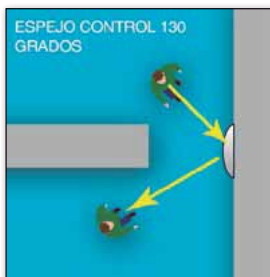

Lente fabricada en policarbonato y trasera en aluminio. Ángulo de visión ajustable de 130°. Alta resistencia al impacto. Incluye tornillos y anclaje para pared.

Ref:	80102	Ø 800mm	5.70 Kg	850x850x130mm	1x
Ref:	80122	Ø 600mm	3.25 Kg	630x630x90mm	1x
Ref:	80131	Ø 450mm	2.35 Kg	480x480x80mm	1x
Ref:	80141	Ø 300mm	0.85 Kg	340x340x60mm	1x



## ESPEJO REFLECTANTE



Lente fabricada en policarbonato y trasera en polipropileno. Ángulo de visión ajustable de 130°. Alta resistencia al impacto. Incluye tornillos y anclaje para tubo. Bandas reflectantes rojas y blancas alrededor del espejo para una mayor visibilidad.

Ref:	80103	Ø 800mm	6.30 Kg	900x900x120mm	1x
Ref:	80123	Ø 600mm	3.30 Kg	670x670x120mm	1x

## ESPEJO HEMISFÉRICO



Lente fabricada en policarbonato. Ángulo de visión de 360°, control en 4 direcciones. Alta resistencia al impacto. Fijación al techo mediante tacos y tornillos incluidos.

Ref:	80111	Ø 650mm	3.65 Kg	730x730x400mm	1x
Ref:	80132	Ø 450mm	2.10 Kg	540x540x320mm	1x

## ESPEJO MEDIO HEMISFÉRICO



Lente fabricada en policarbonato. Ángulo de visión de 180°, control en 3 direcciones. Alta resistencia al impacto. Fijación al techo mediante tacos y tornillos incluidos.

Ref:	80112	Ø 650mm	2.40 Kg	730x420x380mm	1x
Ref:	80133	Ø 450mm	1.35 Kg	540x350x300mm	1x

## ESPEJO CUARTO HEMISFÉRICO



Lente fabricada en policarbonato. Ángulo de visión de 90°, control en 2 direcciones. Alta resistencia al impacto. Fijación al techo mediante tacos y tornillos incluidos.

Ref:	80113	Ø 650mm	1.50 Kg	400x400x400mm	1x
Ref:	80134	Ø 450mm	0.85 Kg	300x300x320mm	1x

## SOPORTES PARA ESPEJOS



80104



80124

80104. Soporte para adaptar espejo exterior de 80 cm a pared.  
80124. Soporte para adaptar espejos de 60 y 45 cm a pared/tubo.

Ref:	80104	Ø 70mm	0.70 Kg	200x160x90mm	1x
Ref:	80124	Ø 60 / 40mm	0.60 Kg	320x80x90mm	1x

## ESPEJO INTERIOR ACRÍLICO



80151



80143

Espejo acrílico de seguridad disponible en tres tamaños diferentes, ideal para controles o para visualizar lugares de difícil acceso.

Ref:	80142	Ø 200mm	0.35 Kg	225x220x45mm	1x
Ref:	80143	Ø 150mm	0.25 Kg	165x160x45mm	1x
Ref:	80151	180x240mm	0.45 Kg	200x250x70mm	1x

## ESPEJO DE INSPECCIÓN



Espejo acrílico de inspección portátil de 30cm, ideal para visualizar lugares de difícil acceso. Ofrece una visión clara y precisa. Perfecto para la inspección bajo los vehículos, máquinas, equipos y áreas de difícil visión. Incluye: palo telescópico de 60cm, extensible hasta 110cm, 4 ruedas, linterna y bolso de mano.

Ref:	80144	1180mm	Ø300mm	1.05 Kg	1x
------	-------	--------	--------	---------	----





## REDUCTOR DE VELOCIDAD - ALTURA 35mm

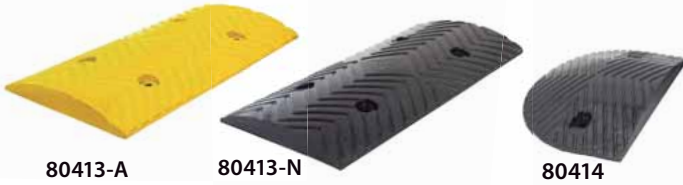

80413-A

80413-N

80414

Fabricado en caucho. Piezas independientes de 500mm en negro o amarillo. Muy resistente a la humedad y a altas temperaturas.

Ref: 80413-N	REDUCTOR	500x250x35mm	4 Kg	1x
Ref: 80413-A	REDUCTOR	500x250x35mm	4 Kg	1x
Ref: 80414	TERMINACIÓN	250x250x35mm	1.80 Kg	1x



## REDUCTOR DE VELOCIDAD - ALTURA 50mm

80416



80415

Fabricado en caucho, muy resistente a la humedad y a altas temperaturas. Cada pieza tiene 4 ojos de gato para una mejor visión nocturna. Fabricado de una pieza mitad amarilla y mitad negra.

Ref: 80415	REDUCTOR	500x350x50mm	8 Kg	1x
Ref: 80416	TERMINACIÓN	250x350x50mm	4 Kg	1x



## REDUCTOR DE VELOCIDAD - ALTURA 30mm



80419

80418

Fabricado en caucho, con 8 cintas reflectantes amarillas de 120x120mm. Instalación fácil mediante tornillos (no incluidos).

Ref: 80418	REDUCTOR	500x600x30mm	9 Kg	1x
Ref: 80419	TERMINACIÓN	225x600x30mm	3 Kg	1x

## REDUCTOR DE VELOCIDAD - ALTURA 50mm



80432

80431

Fabricado en caucho, con 8 cintas reflectantes amarillas de 120x120mm. Instalación fácil mediante tornillos (no incluidos).

Ref: 80431	REDUCTOR	500x600x50mm	12.5 Kg	1x
Ref: 80432	TERMINACIÓN	225x600x50mm	4 Kg	1x

## REDUCTOR DE VELOCIDAD PORTATIL

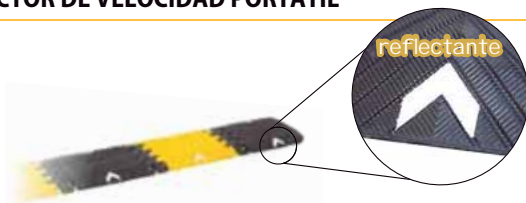

Facil instalación, puede ser plegado en segundos para poder transportarlo a otro lugar. Fabricado en poliuretano. Soporta hasta 20 toneladas. Incluye bolsa de transporte. Medidas plegado: 360x250x310mm.

Ref: 80417		3000x250x25mm	11 Kg	1x
------------	--	---------------	-------	----



## SALVAZANJAS **NUEVO**

Salva zanjas fabricado en polietileno de alta densidad, reforzado con 4 lamas de acero en la parte posterior haciéndolo mucho más firme y resistente. Ideal para tapar zanjas o agujeros temporalmente en las obras, permitiendo el paso de vehículos y peatones. Superficie anti-deslizante. Se recomienda fijación al suelo.



Soporta hasta 1000 Kg

Ref: 80440      1200x800x44mm      18 Kg      1x

## RAMPA **NUEVO**

Rampa portátil fabricada en polietileno de alta densidad, tiene 7 lamas de acero en la parte posterior haciéndola mucho más firme. Superficie antideslizante. Puede usarse temporalmente o permanente fijándolo al suelo mediante tornillos (no incluidos).



Soporta hasta 500 Kg

Ref: 80430      1300x700x85mm      13 Kg      1x

## PROTECTOR DE CABLES

Solución económica, ideal para centros comerciales, zonas de construcción o garajes. Fabricado en poliuretano. Instalación sencilla mediante conexiones en "L", sin necesidad de herramientas. Soporta hasta 1.5 toneladas.



Ref: 80429      1000x133x20mm      Canal de 40x13mm      1.4 Kg      1x

## PROTECTOR PARA CABLES ARTICULADO

Con el nuevo diseño articulado permite girar en esquinas y adaptarse al espacio, ideal para eventos, ferias, obras, etc. Dispone de canal para cable de hasta 10mm o 20mm.



Ref: 80433      3000x80mm      Espacio para cable: 16x10mm      1x

Ref: 80434      3000x150mm      Espacio para cable: 40x19mm      1x

## PROTECTOR PARA CABLES

Ideal para eventos, ferias, obras, etc. Hecho en caucho y con tapa de plástico, dispone de 5 canales para cables de 42mm. Soporta hasta 10 toneladas de peso.



Ref: 80422      900x500x55mm      16 Kg      1x

## PROTECTOR PARA CABLES DE ESQUINA

Fabricado en caucho, con ángulo de 22,5° para formar curvas. Dispone de 5 canales para cables de hasta 42mm. Soporta hasta 10 toneladas de peso.



Ref: 80423      310X500X55mm      4 Kg      1x

## PROTECTOR PARA MANGUERAS

Ideal para eventos, ferias, obras, etc. Hecho en caucho y con tapa de plástico, dispone de 2 canales para cables de 80mm. Soporta hasta 40 toneladas de peso.



Ref: 80428      900X615X105mm      27 Kg      1x



## TOPE DE PARKING 2000mm

Permite estacionar el vehículo en el mismo lugar sin sobrepasar el límite de la plaza de aparcamiento, previniendo accidentes contra obstáculos al maniobrar. También puede usarse como separador de carril. Fabricado en caucho. De fácil y rápido montaje mediante tornillos (no incluidos).



Ref: 80427	2000x150x100mm	17 Kg	1x
------------	----------------	-------	----

## TOPE DE PARKING 500mm

Permite delimitar la extremidad de la plaza de aparcamiento, previniendo accidentes. Fabricado en caucho de una sola pieza. De fácil y rápido montaje mediante tornillos (no incluidos).



Ref: 80421	500x160x100mm	Ø 80mm	4.35 Kg	1x
------------	---------------	--------	---------	----

## TACO Y TORNILLO METÁLICOS

Para material macizo como paredes o suelos de hormigón. Fabricado en metal, anclaje por expansión.



Ref: 80611	50mm	0.09 Kg	1x
Ref: 80613	70mm	0.10 Kg	1x
Ref: 80614	90mm	0.12 Kg	1x

## RAMPA

De gran utilidad para salvar bordillos y pequeños desniveles. Fabricadas en caucho, aguanta hasta 5 toneladas de peso.



80424



80425

Ref: 80424	RAMPA	600x250x100mm	8 Kg	1x
Ref: 80425	TERMINACIÓN	250X250x100mm	1.5 Kg	1x

## PROTECTOR DE MUELLE DE CARGA

Protector diseñado para ofrecer la máxima protección y ahorro de costes debido a los daños causados por camiones, trailers, etc.



Ref: 80435	900x150x150mm	11.45 Kg	1x
------------	---------------	----------	----

## PROTECTOR RECTANGULAR DE MUELLE

Protector diseñado para proteger su plataforma o muelle de carga, disminuyendo a su vez, los costes de reparación y mantenimiento.



Ref: 80436	450x250x105mm	10.55 Kg	1x
------------	---------------	----------	----

## CALZO DE RUEDA

Fabricado en caucho, su diseño está concebido para sujetar las ruedas de vehículos ligeros o pesados.



80437



80438

Ref: 80437	250x160x190mm	2.0 Kg	1x
Ref: 80438	325x290x270mm	10.45 Kg	1x

## PROTECTOR PARA PARKING Y MUELLES DE CARGA

Especialmente diseñado para proteger tanto el vehículo como la pared. Fabricado en caucho con banda reflectante amarilla. Con tres agujeros para atornillar a la pared.



Ref: 80426    1000x160x50mm    5 Kg    1x

## ESQUINERO RECTO

Ideal para proteger esquinas de ángulo recto propensas a recibir golpes. Cuenta con 3 perforados en cada ala. Fabricado en caucho de alta resistencia y vinilo reflectante amarillo.



Ref: 80411    800x100x10mm    Espesor: 10mm    2 Kg    1x

## ESQUINERO CURVO

Ideal para la protección de esquinas de ángulo recto. Con ángulo redondeado para una mayor protección. Dispone de 3 perforados en cada ala. Fabricado en caucho de alta resistencia y vinilo reflectante amarillo.



Ref: 80412    800x120x20mm    Espesor: 20mm    2.6 Kg    1x

## BLOQUEO PARA PARKING CON CANDADO

Bloqueo de parking abatible manual para cierre con candado. Sistema robusto gracias a sus tres puntos de anclaje y de muy fácil uso con su sistema de candado.



Abatible y con bloqueo por candado

Ref: 0080010    400x720mm    5 Kg    1x

## POSTE ABATIBLE CON CERRADURA PARA PARKING

Elegante y resistente poste abatible fabricado en tubo de acero de fácil uso e instalación. Acabado con pintura amarilla resistente a rayos UV para una mejor visibilidad y durabilidad. Viene con cerradura y llaves incluidas.



Acabado con pintura resistente a rayos UV

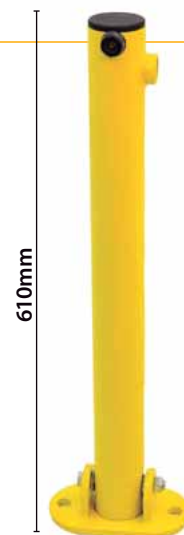

Ref: 80401    610x175x100mm    Tubo: Ø 60mm    4.5 Kg    1x







# PROTECTORES DE ESPUMA PU

## PROTECTORES DE ESPUMA PU

Fabricado en espuma de poliuretano de alta densidad, gran resistencia al impacto volviendo a su estado y características originales después del golpe. Resistente a los rayos UV, se puede cortar fácilmente a la longitud deseada con un cutter o cuchillo de sierra. Incluye adhesivo 3M. Función: Anti-colisión, protección al impacto con bordes, protege y resalta los salientes de muebles, estanterías, esquinas, maquinaria, etc. Ésta espuma puede soportar temperaturas de -40° a + 90° - siendo ideal para cualquier entorno industrial, interior o exterior.





### PROTECTOR PARA ESQUINA



Ref: 80325	45x45x1040mm	Grosor 10mm		0.35 Kg	1x 
Ref: 80322	Ø 40mm	Ø 40mm		0.35 Kg	1x 





### PROTECTOR PARA BORDE



Ref: 80323	40x40x1010mm	Grosor: 40mm		0.4Kg	1x 
Ref: 80321	Ø40x1030mm	Grosor: 40mm		0.35Kg	1x 





### PROTECTOR SEMICÍRCULO



Ref: 80327-RD	Ø30x50x1000mm	Grosor: 10mm		0.25Kg	1x 
Ref: 80327-YE	Ø30x50x1000mm	Grosor: 10mm		0.25Kg	1x 



### PROTECTOR SEMICÍRCULO



Ref: 80328-RD	Ø50x70x1000mm	Grosor: 10mm		0.30Kg	1x 
Ref: 80328-YE	Ø50x70x1000mm	Grosor: 10mm		0.30Kg	1x 

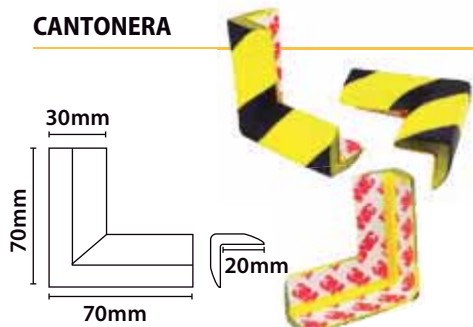

### CANTONERA



Ref: 80329	70x30x10mm		0.02 Kg	1x 
------------	------------	---	---------	--

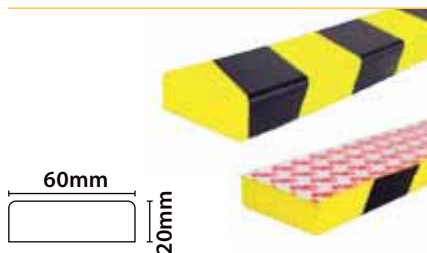

### PROTECTOR PARA SUPERFICIE

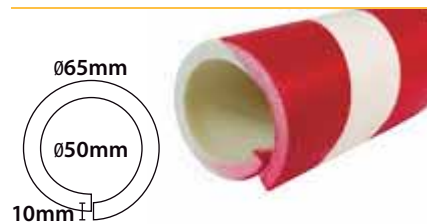

Ref: 80324	60x20x1020mm		0.35Kg	1x 
------------	--------------	---	--------	--

### PROTECTOR CÍRCULO



Ref: 80326	Ø65x1000x10mm		0.5Kg	1x 
------------	---------------	---	-------	--



## PROTECCIÓN PARA POSTES Y ESTANTERÍAS "L"

Ideal para la protección de sus estantes contra los choques de las máquinas de mantenimiento en el almacén.

Ref: 00800105	400mm	4.0 Kg	1x 
Ref: 00800106	800mm	7.9 Kg	1x 
Ref: 00800107	1200mm	11.5 Kg	1x 



## PROTECCIÓN PARA POSTES Y ESTANTERÍAS "U"

Ideal para la protección de sus estantes contra los choques de las máquinas de mantenimiento en el almacén.

Ref: 00800108	400mm	5.5 Kg	1x 
Ref: 00800109	800mm	10.5 Kg	1x 
Ref: 00800110	1200mm	15.7 Kg	1x 



## ARCOS DE PROTECCIÓN

Tubo de acero galvanizado. Ideal para la protección de equipos, postes, tuberías, maquinaria, etc. de los choques de vehículos.

Ref: 00800102	600x200x750mm	Ø 60mm	9.45 Kg	1x 
Ref: 00800103	600x200x1000mm	Ø 60mm	9.95 Kg	1x 
Ref: 00800104	1200x200x1000mm	Ø 60mm	12.5 Kg	1x 





## ARCOS DE PROTECCIÓN 90 °

Ref: 00800100	Alto: 600mm	Ala: 500mm	Ø 60mm	14.3 Kg	1x 
Ref: 00800101	Alto: 1200mm	Ala: 500mm	Ø 60mm	18.5 Kg	1x 



## LARGUEROS DE PROTECCIÓN

Ofrecen protección para vehículos sin impedir el acceso de los peatones. Ideal para proteger estanterías y máquinas de los impactos con equipos de manipulación. Extremos en corte de 45°.

Ref: 00800111	400mm	Ø 60mm	2.9 Kg	1x 
Ref: 00800112	800mm	Ø 60mm	5.1 Kg	1x 
Ref: 00800113	1200mm	Ø 60mm	7.15 Kg	1x 





## DISPLAY PARA GRÁFICAS "MELGAR"

Atril a una o dos caras para exposición de gráficas. Posibilidad de girar la gráfica para presentarla en horizontal o vertical. Rápido cambio de gráfica gracias al sistema "click". Fabricado en aluminio.



Ref: 10344	A4	Una cara	1x
Ref: 10579	A3	Una cara	1x
Ref: 10345	A4	Dos caras	1x
Ref: 10580	A3	Dos caras	1x

## ATRIL "ULSTER"

Atril a una cara, fabricado en aluminio.



Ref: 10982	A3	1200x452x300mm	1x
------------	----	----------------	----

## ATRIL "ZAFRA"

Atril a una cara, fabricado en aluminio.



Ref: 10158	A4	960x311x330mm	1x
Ref: 10159	A3	998x453x330mm	1x

## PORTAFOLLETOS "SAGRES"

Portafolletos para formato A4.



Ref: 10474	A4	Acero	1000x250x330mm	1x
Ref: 10476	A5	Acero	1000x250x330mm	1x
Ref: 10473	A4	Acrílico	1000x250x330mm	1x
Ref: 10475	A5	Acrílico	1000x250x330mm	1x

## STAND PARA PORTAFOLLETOS ACRÍLICO

Portafolletos realizado en acrílico y estructura en aluminio. Elemento decorativo intercambiable para la base.

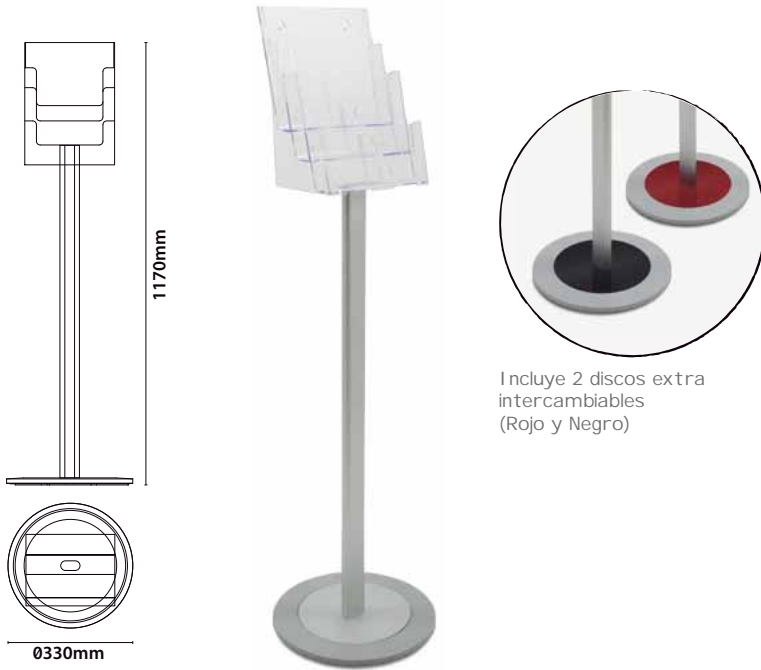

Incluye 2 discos extra intercambiables (Rojo y Negro)

Ref: 14100 x3 A4 1170x330mm 1x

## STAND PARA URNA

Stand para urna, realizado en acrílico y estructura en aluminio.

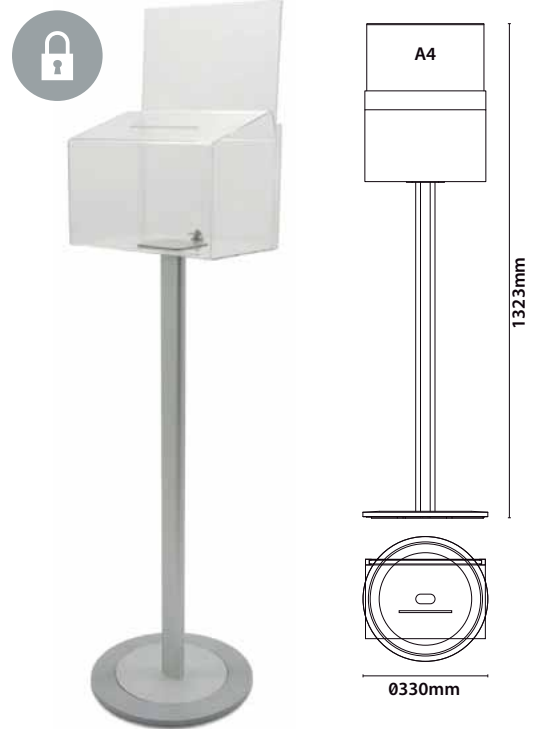

Ref: 14101 Urna 222x317x210 +A4 1323x330mm 1x

## URNAS DE METACRILATO

URNAS en metacrilato con ranura para insertar tarjetas y cartela para gráfica. Disponible en varios tamaños con y sin cerradura.



Disponible con y sin cerradura

Ref: 13099	175x130x220mm	150x100mm	Sin cerradura	2x
Ref: 13100	175x130x220mm	150x100mm	Con cerradura	2x
Ref: 13124	432x316x210mm	A4	Con cerradura	1x
Ref: 13375	390x224x210mm	A5	Con cerradura	1x



## URNA DE CARTÓN "TRIESTE"

Urna fabricada en cartón con portafolletos laterales y espacio para posible gráfica superior.

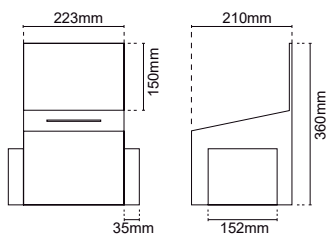

Ref: 13080 360x223x210mm Sin cerradura 5x









## PIZARRA CON FONDO DE CORCHO

Tablero de corcho enmarcado en aluminio. Ideal para fijación de documentos con alfileres o chinchetas. 4 tamaños disponibles.



\* Anclajes incluidos

Ref: 10320	4 x A4	502x672mm	1x 
Ref: 10321	6 x A4	502x992mm	1x 
Ref: 10325	9 x A4	732x992mm	1x 
Ref: 10328	12 x A4	962x992mm	1x 



## PIZARRA CON FONDO DE CORCHO

Tablero de corcho enmarcado en aluminio con esquinas de plástico. Ideal para la fijación de documentos mediante alfileres o chinchetas. Grosor del corcho 8mm. Disponible en 6 tamaños.

Ref: 14008	600x450mm	Fondo de corcho	1x 
Ref: 14009	900x600mm	Fondo de corcho	1x 
Ref: 14010	1200x900mm	Fondo de corcho	1x 
Ref: 14011	1500x900mm	Fondo de corcho	1x 
Ref: 14012	1500x1200mm	Fondo de corcho	1x 
Ref: 14013	1800x1200mm	Fondo de corcho	1x 

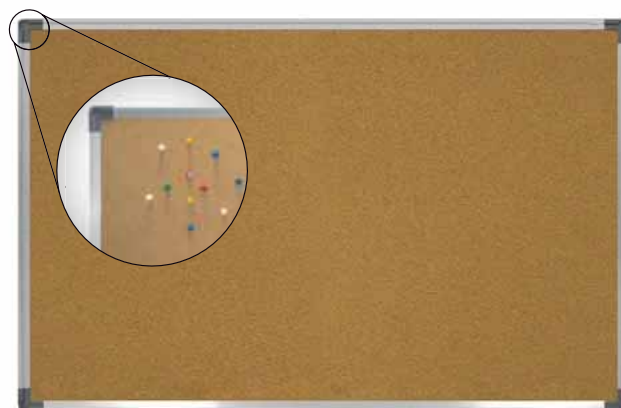



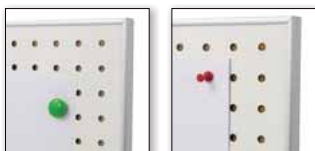

## PIZARRA "SELLES"

Pizarra magnética blanca perforada con panel de corcho interior. Apta para emplearse con imanes y/o chinchetas.



Para imanes y/o chinchetas

Ref: 10333	4 x A4	502x672mm	1x 
Ref: 10334	6 x A4	502x992mm	1x 
Ref: 14096	9 x A4	732x992mm	1x 
Ref: 14097	12 x A4	962x992mm	1x 



## PIZARRA BLANCA MAGNÉTICA

Pizarra blanca a una cara enmarcada en aluminio anodizado, grosor 18mm, trasera galvanizada, esquinas de plástico y bandeja porta rotuladores. Permite escribir con rotuladores borrables o colocar documentos mediante imanes. Fácil limpieza.



\*Para uso con imanes

Ref: 14000	600x900mm	Magnética	1x
Ref: 14001	900x1200mm	Magnética	1x
Ref: 14002	1200x1500mm	Magnética	1x
Ref: 14003	1200x1800mm	Magnética	1x
Ref: 14004	1200x2000mm	Magnética	1x



## PIZARRA BLANCA MAGNÉTICA "RENNES"

Pizarra blanca a una cara enmarcada en aluminio anodizado, grosor 18mm, trasera galvanizada, esquinas de plástico y bandeja porta rotuladores. Permite escribir con rotuladores borrables o colocar documentos mediante imanes. Fácil limpieza.

Fácil de limpiar para imanes y rotuladores

1 manes disponibles (no incluidos).



Ref: 10329	4 x A4	502x672mm	1x
Ref: 14094	6 x A4	502x992mm	1x
Ref: 14095	9 x A4	732x992mm	1x
Ref: 10332	12 x A4	962x992mm	1x



## IMANES

Imanes para pizarra o vitrina. Colores surtidos. Disponible en 3 tamaños.

## BORRADOR

Borrador para pizarras blancas realizado en plástico.

## CHINCHETAS

Cada caja contiene 100 unidades en colores surtidos.



Ref: 14031	Ø 20mm	12 uni./pack	1x
Ref: 14032	Ø 30mm	6 uni./pack	1x
Ref: 14033	Ø 40mm	4 uni./pack	1x



Ref: 14030	Para pizarras blancas	1x
------------	-----------------------	----



Ref: 14034	100 unidades por caja	1x
------------	-----------------------	----



## VITRINA PARA ANUNCIOS

Vitrinas para anuncios realizadas en corcho o magnéticas, para su colocación en pared. Marco de aluminio, frontal en PC y cerradura lateral. Ideal para la fijación mediante imanes (fondo metálico) o chinchetas (fondo de corcho) de notas, documentos, mensajes, etc.



\* Chinchetas o imanes no incluidos

Ref: 14084	500x700mm	Fondo de corcho	1x
Ref: 14085	600x800mm	Fondo de corcho	1x
Ref: 14086	700x1000mm	Fondo de corcho	1x
Ref: 14087	500x700mm	Fondo metálico	1x
Ref: 14088	600x800mm	Fondo metálico	1x
Ref: 14089	700x1000mm	Fondo metálico	1x

## VITRINA PARA ANUNCIOS

Vitrina para anuncios con fondo de corcho o metálico. Marco de aluminio y puerta de metacrilato provista de cerradura. Ideal para la fijación de notas, documentos, etc. La fijación, según sea el fondo de corcho o metálico, será mediante chinchetas o imanes.



\* Chinchetas o imanes no incluidos

Ref: 14092	250x400mm	Fondo de metálico	1x
Ref: 14045	350x500mm	Fondo de metálico	1x
Ref: 14046	500x700mm	Fondo de metálico	1x
Ref: 14093	600x600mm	Fondo de metálico	1x

Ref: 14090	250x400mm	Fondo de corcho	1x
Ref: 14043	350x500mm	Fondo de corcho	1x
Ref: 14044	500x700mm	Fondo de corcho	1x
Ref: 14091	600x600mm	Fondo de corcho	1x

## VITRINA PARA ANUNCIOS

Vitrinas para anuncios realizadas con fondo metálico, para su colocación en pared. Marco de aluminio, frontal en PC y cerradura lateral. Ideal para la fijación mediante imanes de notificaciones, documentos, mensajes, etc. Diseñadas para su uso en exterior (Waterproof).



Vitrina waterproof, ideal para su uso en exterior



Ref: 14058	1000x840mm	Fondo metálico	1x
Ref: 14059	750x1090mm	Fondo metálico	1x
Ref: 14060	750x660mm	Fondo metálico	1x
Ref: 14061	1150x940mm	Fondo metálico	1x
Ref: 14064	850x1240mm	Fondo metálico	1x

## VITRINA PARA ANUNCIOS "WATERLOO"

Vitrinas para anuncios con fondo metálico. Marco de aluminio con puerta de metacrilato y cerradura. Ideal para la fijación de documentos mediante imanes.



\* Anclajes incluidos



Ref: 14156	1xA4	Tamaño externo: 250x351x37mm	1.45 Kg	1x
Ref: 14157	2xA4	Tamaño externo: 460x351x37mm	2.43 Kg	1x



## PEANA "PANELFIX WING STEEL"

Fabricadas en acero y disponibles en 300mm y 500mm de ancho. Permite la sujeción de soportes de hasta 20mm de espesor. La altura máxima recomendada para la gráfica es de 1500mm.

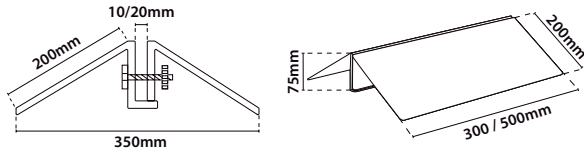

Permite la impresión para personalización en ambos lados de la base

Ref: 10065	300mm	2.75 Kg		1x
Ref: 10066	500mm	4.55 Kg		1x



## PEANA "BALBOA"

Fabricadas en acero y disponibles en negro y blanco. Permite la sujeción de soportes de hasta 11mm de espesor. Medidas 295x295mm y altura de 200mm. Base de 5mm de espesor.

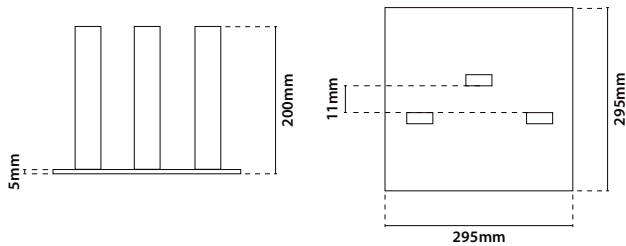

Ref: 10894	295x295mm	9 Kg		2x
Ref: 10895	295x295mm	9 Kg		2x



## PEANA "MONTIJO"

Fabricadas en acero y disponibles en negro y blanco. Permite la sujeción de soportes de hasta 10mm de espesor. Ø300mm y 200mm de altura. Base de 5mm de espesor.

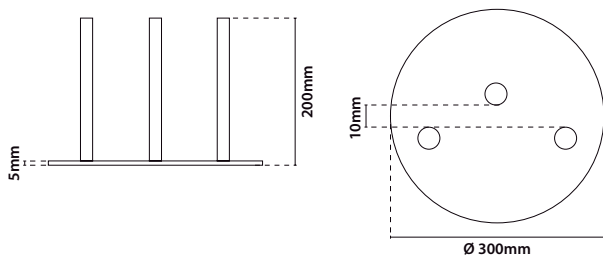

Ref: 10898	Negro	7.2 Kg		2x
Ref: 10838	Blanco	7.2 Kg		2x



## DISPLAY DE ACERO 1

Estructura fabricada en acero. Visual de gráfica: 470x664mm

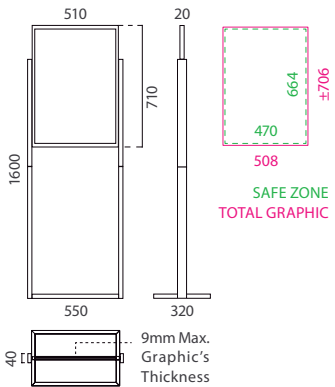

Estructura pintada en negro



Ref: 10996 320x550x1600mm 8.65 Kg

1x

## DISPLAY DE ACERO 2

Estructura fabricada en acero. Visual de gráfica: 470x1370mm

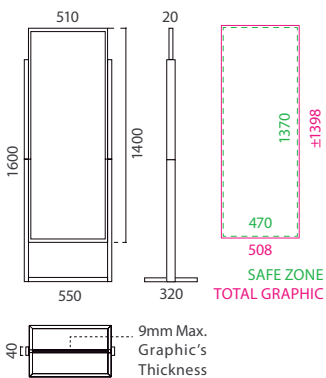

Estructura pintada en negro



Ref: 10997 320x550x1600mm 9.5 Kg

1x

## BANNER "OCEAN"

Estructura en aluminio y base rellenable de plástico. Doble cara.

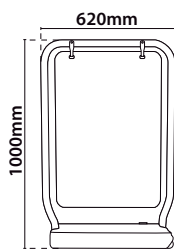

Base con ruedas

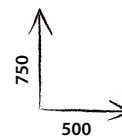

Base rellenable de 10 litros de agua.



Ref: 10305 1000x620x400mm 5.4 Kg

1x



## SISTEMA "STRONG CLIP"

Kit sistema de soporte de gráfica mediante suspensión.



3 Tamaños  
3 Colores  
disponibles:  
-Transparente  
-Blanco  
-Negro

### 500mm

Ref: 10630	500mm	0.52 Kg		12x
Ref: 10631	500mm	0.52 Kg		12x
Ref: 10632	500mm	0.52 Kg		12x

### 800mm

Ref: 10633	800mm	1 Kg		12x
Ref: 10634	800mm	1 Kg		12x
Ref: 10635	800mm	1 Kg		12x

### 1000mm

Ref: 10636	1000mm	1.2 Kg		12x
Ref: 10637	1000mm	1.2 Kg		12x
Ref: 10638	1000mm	1.2 Kg		12x

## SISTEMA "ALUGRIP"

Kit sistema de soporte de gráfica mediante suspensión.



Cada Kit contiene:

- 2 Tapas de plástico
- Grippers
- Colgadores
- 1 Barra/perfil



Ref: 10172	300mm	0.31 Kg	4x
Ref: 10173	500mm	0.51 Kg	4x
Ref: 10174	700mm	0.7 Kg	4x
Ref: 10175	1000mm	1 Kg	4x

### GRIPPER PARA "ALUGRIP"

Ref: 10176	50mm	0.025 Kg	10x
------------	------	----------	-----



### TAPA PARA "ALUGRIP"

Ref: 10177		0.007 Kg	10x
------------	--	----------	-----



### COLGADOR PARA "ALUGRIP"

Ref: 10178		0.005 Kg	10x
------------	--	----------	-----



### COLGADOR PARA "ALUGRIP"

Ref: 10179		0.006 Kg	10x
------------	--	----------	-----



## CLIP VERTICAL / HORIZONTAL

Clip vertical u horizontal para encajar en los riles de los falsos techos.

Ref: 12132 Vertical 23x20mm 100x 

Ref: 12133 Horizontal 20x20mm 100x 



## BOTÓN ADHESIVO REDONDO

Botón adhesivo redondo con gancho cerrado. Color blanco.

Ref: 12301 Ø 18mm 100x 



## CARPETAS DE METACRILATO

Carpetas en metacrilato transparente, formato horizontal y vertical.

Ref: 12125 A4 Horizontal 10x 

Ref: 12126 A4 Vertical 10x 

Ref: 12351 A3 Horizontal 10x 

Ref: 12352 A3 Vertical 10x 



## IMÁN CIRCULAR CON GANCHO ABIERTO

Imán circular con gancho abierto.



Ref: 12167 Ø 25mm Para Peso <650 g 25x 

Ref: 12347 Ø 32mm Para Peso <1600 g 20x 

Ref: 12348 Ø 40mm Para Peso <2000 g 10x 

Ref: 12349 Ø 50mm Para Peso <5100 g 10x 

Ref: 12350 Ø 63mm Para Peso <5500 g 10x 

## BOTÓN ADHESIVO CUADRADO

Botón adhesivo cuadrado con gancho cerrado. Color blanco.

Ref: 12129 20x20mm 100x 



## BOTÓN ADHESIVO GANCHO ABIERTO

Botón adhesivo cuadrado con gancho abierto. Color blanco.

Ref: 12131 24x24mm 100x 



## VARILLA CON DOBLE GANCHO

Ideal para combinar con los diferentes sistemas para colgar cartelería.

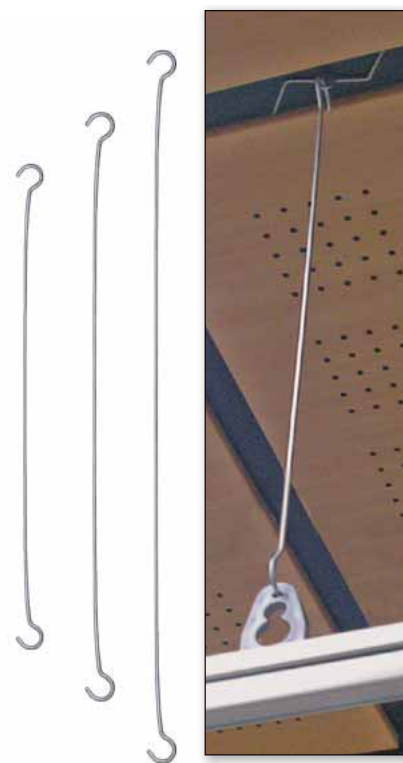

Ref: 12141 100mm 50x 

Ref: 12142 150mm 50x 

Ref: 12143 200mm 50x 

Ref: 12144 300mm 50x 

Ref: 12145 400mm 50x 

Ref: 12146 500mm 50x 

Ref: 12147 600mm 50x 

Ref: 12148 750mm 50x 

Ref: 12149 900mm 50x 

Ref: 12150 1000mm 50x 

## IMÁN RECTANGULAR

Imán especial para techo técnico.



Ref: 12478 28x14x38mm 50x 





## PERFIL PORTA-BANNER PARA PARED

Sistema de perfilera para la exhibición de gráficas. Ideal para el exterior. Estructura de aluminio anodizado color plata.

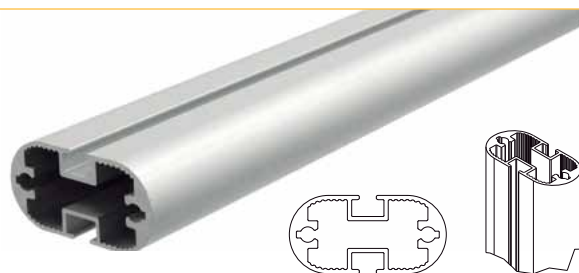

Ref: 13483	3000mm	11.77 Kg		4x
Ref: 13484	2000mm	3.92 Kg		2x

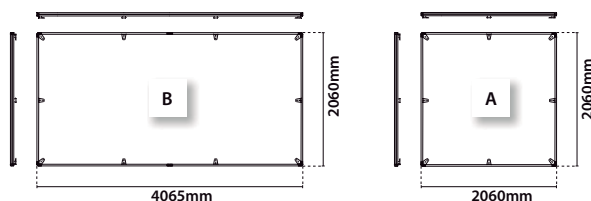

### SOPORTE PARA ESQUINA

Esquina para Porta-Banner de Pared.

Ref: 13485	0.52 Kg		4x
------------	---------	--	----



### SOPORTE PARA TRAMO RECTO

Soporte para Porta-Banner de Pared.

Ref: 13486	0.41 Kg		4x
------------	---------	--	----



### CONEXIÓN PARA ESQUINA

Conexión de esquina para Porta-Banner de Pared.

Ref: 13487	0.14 Kg		8x
------------	---------	--	----



### CONEXIÓN PARA PERFIL

Conexión para perfil de Porta-Banner de Pared.

Ref: 13488	0.11 Kg		4x
------------	---------	--	----



### COLGADOR CANVAS

Colgador para perfilera de Porta-Banner de Pared.

Ref: 13334		10x
------------	--	-----

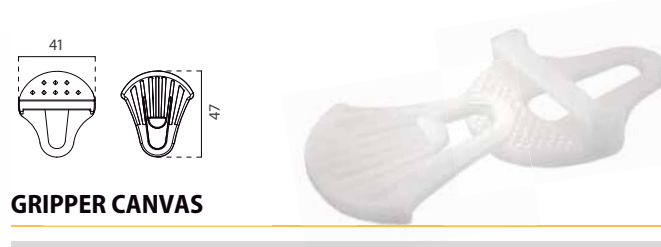

### GRIPPER CANVAS

Gripper para sujeción de gráficas.

Ref: 16110		40x
------------	--	-----

## MÁSTIL DE EXTERIOR A PARED

Soporte de gráfica para colocación sobre pared. Para exterior.

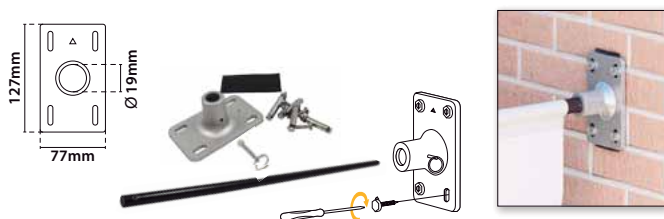

Ref: 10202	Mástil: 800mm	1x	
Ref: 10203	Mástil: 1000mm	1x	
Ref: 10204	Mástil: 1200mm	1x	

## MÁSTIL DE EXTERIOR PARA POSTE

Soporte de gráfica para colocación sobre postes de exterior.

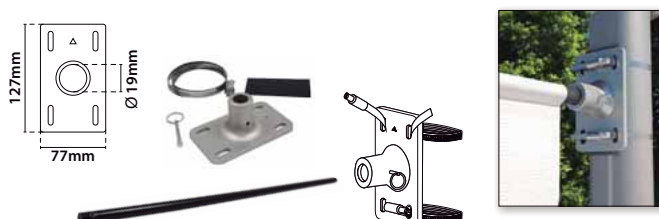

Ref: 10071	Mástil: 800mm	1x	
Ref: 10072	Mástil: 1000mm	1x	
Ref: 10073	Mástil: 1200mm	1x	

## SOPORTE EXTERIOR A PARED

Soporte de gráfica para colocación sobre pared. Para exterior.

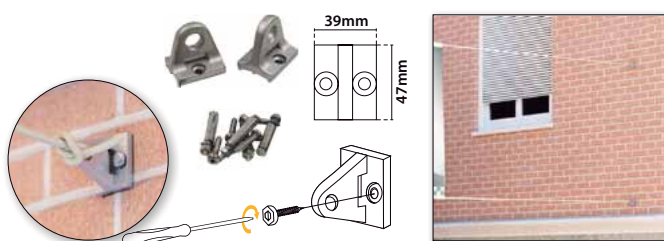

Ref: 10100	47x39mm	1x	
------------	---------	----	--

## SOPORTE EXTERIOR PARA POSTE

Soporte de gráfica para colocación sobre pared. Para exterior.

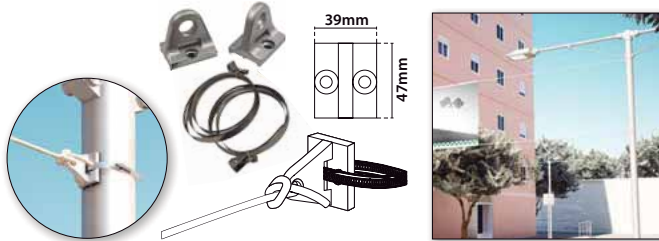

Ref: 10099	47x39mm	1x	
------------	---------	----	--

## SOPORTE DE GRÁFICAS PARA FAROLAS CON MÁSTIL

Soporte de material gráfico para farolas, postes, etc. Cada Kit: 1 pieza de aluminio para suspensión a poste, 1 pasador con 1 anilla, 2 abrazaderas de acero y 1 poste de fibra de vidrio de 600 o 1000mm.

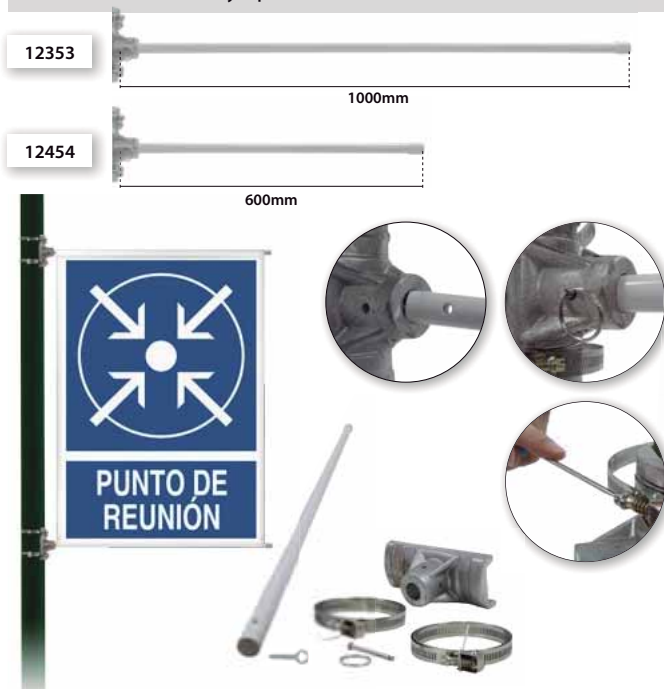

Ref: 12454	Mástil: 600mm	0.6 Kg	1x	
Ref: 12353	Mástil: 1000mm	1 Kg	1x	

## MÁSTIL A PARED

Sistema de anclaje a pared en acero inoxidable.



Ref: 10453	Ø 40x450mm	2.20 Kg	1x	
Ref: 10454	Ø 40x600mm	2.46 Kg	1x	



## PORTAGRÁFICAS ACRÍLICO EN "T" ABIERTA

Este soporte acrílico en forma de "T" invertida con orientación vertical u horizontal está disponible en 6 tamaños diferentes. Está diseñado como soporte de dos gráficas, una por cada cara del display. Las imágenes se introducen fácilmente por los laterales y parte inferior.

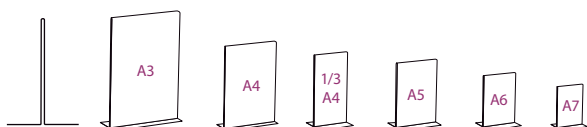
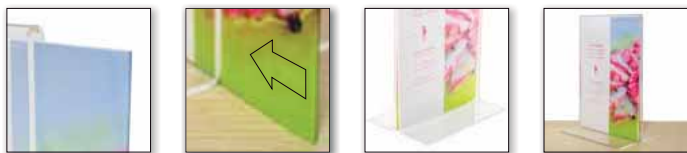

### VERTICAL

Ref: 13069-P	A3	Grosor: 3mm	6x
Ref: 13027-P	A4	Grosor: 2mm	10x
Ref: 13028-P	A5	Grosor: 2mm	10x
Ref: 13068-P	A6	Grosor: 2mm	10x
Ref: 13147-P	A7	Grosor: 2mm	10x
Ref: 13148-P	1/3 A4	Grosor: 2mm	10x



### HORIZONTAL

Ref: 13069-L	A3	Grosor: 3mm	6x
Ref: 13027-L	A4	Grosor: 2mm	10x
Ref: 13028-L	A5	Grosor: 2mm	10x
Ref: 13068-L	A6	Grosor: 2mm	10x
Ref: 13147-L	A7	Grosor: 2mm	10x
Ref: 13148-L	1/3 A4	Grosor: 2mm	10x

## BASE PORTAGRÁFICAS

Este soporte se compone de una base plástica disponible en 3 colores, y una funda transparente portadocumentos, en 4 diferentes tamaños.



gráfica intercambiable de forma sencilla

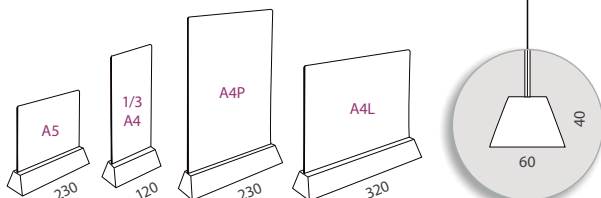

\* Serigrafía no incluida

Ref: 50439	A4 horizontal 297x210mm		10x
Ref: 50435	A4 vertical 297x210mm		10x
Ref: 50437	1/3 A4 vertical 100x210mm		10x
Ref: 50134	A5 vertical 210x148mm		10x

## PORTAFOLLETOS **NUEVO**

Portafolletos fabricado en acrílico y diseñado para su anclaje a pared, o bien para fijarse con ventosas o peana. Disponible en 3 tamaños diferentes.

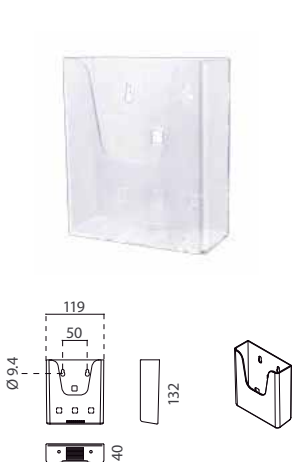

Ref: 13561 Tamaño: A6 10x

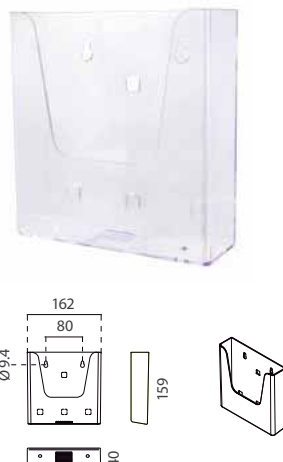

Ref: 13560 Tamaño: A5 10x

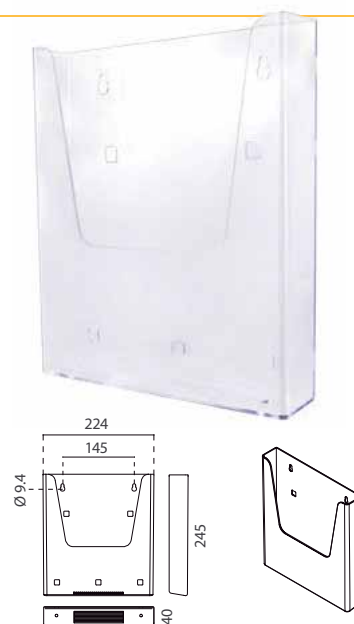

Ref: 13559 Tamaño: A4 10x

## ACCESORIOS PARA PORTAFOLLETOS

Los accesorios acrílicos permiten la utilización de los portafolletos en múltiples combinaciones posibles:

- Para mostradores ( con la ref. 13.499).
- Con ventosas (ref. 12.171).
- Con colgadores (ref. 13.406).

\* dispensadores vendidos por separado.

## PEANAS

Pueden utilizarse una o dos unidades, dependiendo del modelo de portafolletos. Se vende en packs de 20 unidades.



Ref: 13499 45x17x89mm 20 uni./pack 1x

## VENTOSAS DE DOBLE SUCCIÓN

Estas ventosas de doble succión, proporciona al display una adhesión extra. Pueden utilizarse 3 o 4 unidades de acuerdo al modelo de portafolletos. Ideal para fijar a superficies lisas. Vendidas en packs de 100 unidades.



doble succión  
para una adhesión  
extra

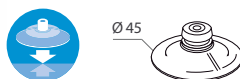

Ref: 12171 Ø 45mm 100 uni./pack 1x

## COLGADOR

Colgador de metal con tres ganchos, para ser utilizado en estanterías con portafolletos. Se vende en packs de 10 unidades.

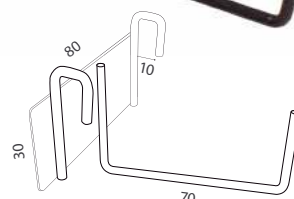

Ref: 13406 80x30x70mm 10 uni./pack 1x



## MARCOS ABS

Sistema de cartelería con marcos ABS en varios colores.

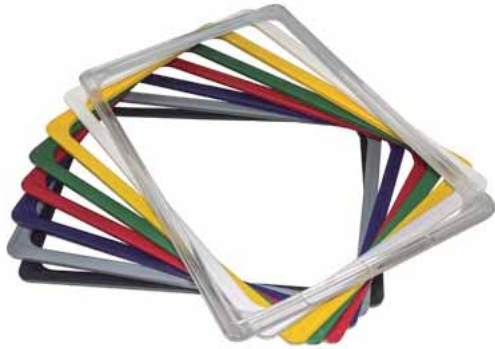

Ref: 12053	A6	105x148mm		10x
Ref: 12054	A5	148x210mm		10x
Ref: 12055	A4	210x297mm		10x
Ref: 12056	A3	297x420mm		10x

## STAND TELESCÓPICO

Compuesto de tubo telescópico + Pinza "T" + Base de plástico



12239



12240



12238

### BASE DE PLÁSTICO

Ref: 12239	Tubos: 150+150mm		10x
Ref: 12240	Tubos: 150+150mm		10x
Ref: 12062	Tubos: 300+300mm		10x
Ref: 12063	Tubos: 300+300mm		10x
Ref: 12065	Tubos: 500+500mm		10x
Ref: 12066	Tubos: 500+500mm		10x
Ref: 12242	Tubos: 750+750mm		10x
Ref: 12243	Tubos: 750+750mm		10x

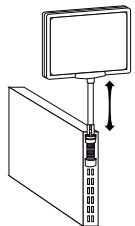
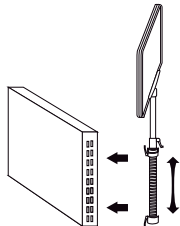

## STAND EXTENSIBLE CON MUELLE

Compuesto por tubo + Pinza + Muelle extensible

Ref: 12069	250mm	10x
------------	-------	-----

## FUNDAS PROTECTORAS

Fundas de plástico en glasspack "antireflex" transparente de 0.3mm

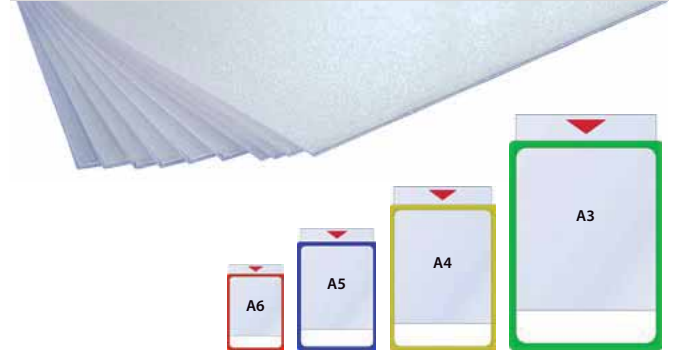

Ref: 12057	A6	105x148mm	20x
Ref: 12058	A5	148x210mm	20x
Ref: 12059	A4	210x297mm	20x
Ref: 12060	A3	297x420mm	10x

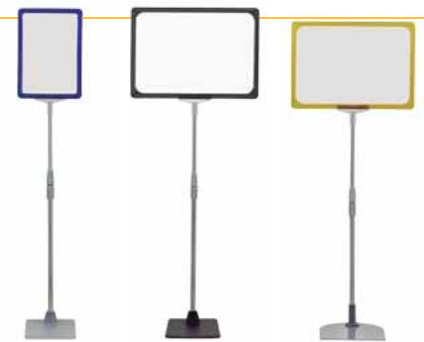

## BASE METÁLICA

Ref: 12238	Tubos: 150+150mm	10x
Ref: 12061	Tubos: 300+300mm	10x
Ref: 12064	Tubos: 500+500mm	10x
Ref: 12241	Tubos: 750+750mm	10x

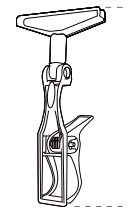
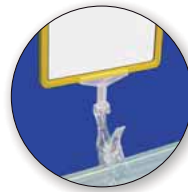

180mm



## PINZA PORTA-PRECIOS

Pinza transparente portaprecios + Soporte en "T"

Ref: 12291	180mm	20x
------------	-------	-----

Permite la colocación de la base debajo de los palés para aproximar la gráfica al producto



## PINZA PARA PALÉ

Pinza soporte especial para palés.

Ref: 12400	250mm	10x
------------	-------	-----

## SISTEMAS DE IDENTIFICACIÓN PERSONAL

Sistemas para la identificación personal con diferentes soportes y acabados disponibles (magnéticos, adhesivos, impermeables...)

### PASADOR PORTA-TARJETA

Incluye pasador y porta-tarjetas.



Ref: 12439 40x12mm ■ 50x

### PASADOR PORTA-TARJETA

Incluye pasador y porta-tarjetas.



Ref: 12440 40x7mm ■ 50x

### PASADOR PORTA-TARJETA

Incluye pasador y porta-tarjetas.



Ref: 12441 52x20mm ■ 50x

### PORTA-TARJETAS ADHESIVO

Con impermeable y adhesivo.



Ref: 12100 32x12mm 100x

### PASADOR PORTA-TARJETA ADHESIVO

Con pasador y adhesivo.



Ref: 12101 40x10mm 100x

### CLIP PORTA-TARJETAS ADHESIVO

Con clip y adhesivo cuadrado.



Ref: 12102 19x19mm 100x

### CLIP PORTA-TARJETAS

Clip metálico porta-tarjetas.



Ref: 12442 24x12mm 50x

### CLIP PORTA-TARJETAS CON PASADOR

Clip con impermeable porta-tarjetas.



Ref: 12443 25x15mm 50x

### CLIP PORTA-TARJETAS

Clip metálico porta-tarjetas.



Ref: 12164 10x27mm 100x

### PINZA PORTA-TARJETAS

Pinza porta-tarjetas de color negro o azul.



Ref: 12435 ■ 50x

Ref: 12436 ■ 50x

### PINZA PORTA-TARJETAS

Pinza porta-tarjetas plateada o de clip reducido negro.



Ref: 12437 ■ 50x

Ref: 12438 ■ 50x

### PINZA PORTA-TARJETAS

Pinza porta-tarjetas cromada con tira transparente.



Ref: 12110 100x

### PINZA PORTA-TARJETAS MAGNÉTICO

Pinza magnética porta-tarjetas azul con tira transparente.



Ref: 12433 ■ 50x



## PORTA-TARJETAS ACRÍLICO

Porta-tarjetas acrílico con clip e impermeable.



Ref: 12390      50x40mm      10x

## PORTA-TARJETAS ACRÍLICO

Porta-tarjetas acrílico con clip e impermeable.



Ref: 12391      60x25mm      10x

## PORTA-TARJETAS ENMARCADO

Porta-tarjetas enmarcado que incluye pasador.



Ref: 12398      75x25mm           10x

Ref: 12399      75x35mm           10x

## PORTA-TARJETAS ENMARCADO MAGNÉTICO

Porta-tarjetas magnético enmarcado.



Ref: 12396      75x25mm           10x

Ref: 12397      75x35mm           10x

## PORTA-TARJETAS CURVO

Porta-tarjetas curvo con pasador.



Ref: 12394      75x32mm           10x

Ref: 12395      75x32mm           10x

## PORTA-TARJETAS CURVO MAGNÉTICO

Porta-tarjetas magnético curvo con pasador.



Ref: 12392      75x32mm           10x

Ref: 12393      75x32mm           10x

## PORTA-TARJETAS CON CUBIERTA TRANSPARENTE

Porta-tarjetas transparente con clip e impermeable.



Ref: 12105      90x55mm      50x



## EXPOSITORES DE SEÑALES

Sencillez y funcionalidad, así como una robustez y durabilidad excelente, son las características principales de nuestros expositores para señalética de seguridad.

Con ellos, podrá exponer a sus clientes un gran número de señales en un espacio muy reducido, clasificadas por tipologías y tamaños, simplificando la compra.

Es la forma perfecta para aumentar las ventas de señalética en su negocio.



### EXPOSITOR DE SUELO

Ref: 81321	Ø600x1700mm			1x
Tamaño:	A3	A4	A5	Total
Capacidad:	125 Uni.	375 Uni.	375 Uni.	875 Uni.

\*Señales no incluidas

### EXPOSITOR DE MESA

Ref: 81320	Ø450x590mm		1x
Tamaño:	175x45mm	250x62mm	Total
Capacidad:	480 Uni.	960 Uni.	1440 Uni.

\*Señales no incluidas



## ACCESORIOS PARA EXPOSITORES

Etiquetas adhesivas, para colocar o reparar producto en blister.

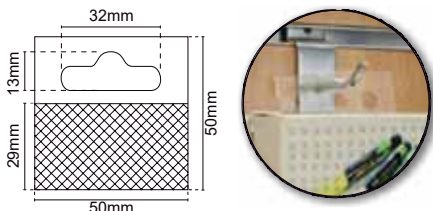

**"EUROSLOT"**

Ref: 12357    Peso max. ±450g    100x

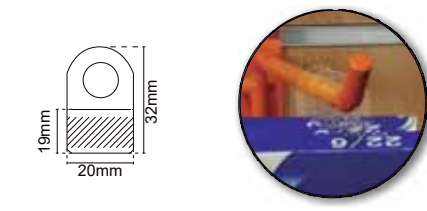

**"STANDARD"**

Ref: 12358    Peso max. ±110g    100x

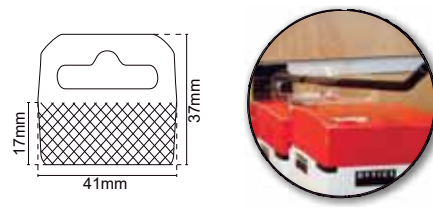

**"FLEXI"**

Ref: 12359    Peso max. ±230g    100x

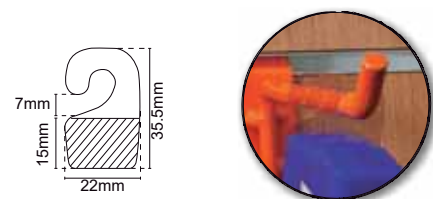

**"HOOK"**

Ref: 12360    Peso max. ±120g    100x

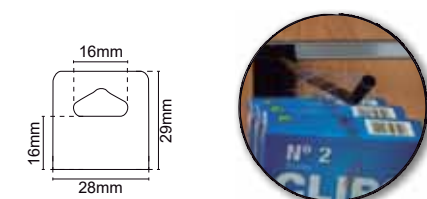

**"EASY"**

Ref: 12361    Peso max. ±185g    100x

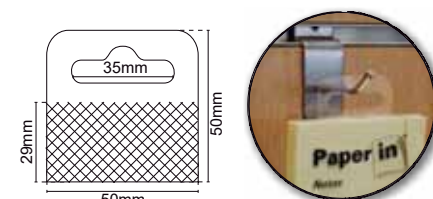

**"NOVA"**

Ref: 12362    Peso max. ±400g    100x

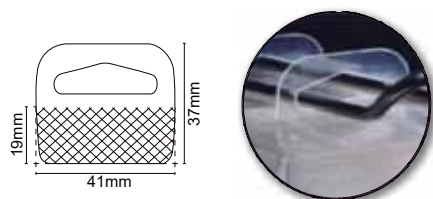

**"FOLDING"**

Ref: 12363    Peso max. ±230g    100x

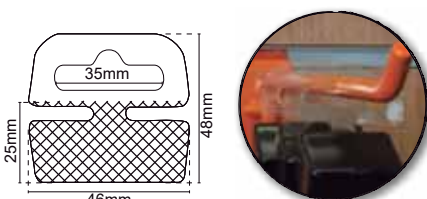

**"QUICK"**

Ref: 12364    Peso max. ±400g    100x

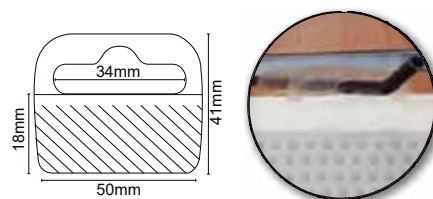

**"USE"**

Ref: 12365    Peso max. ±400g    100x

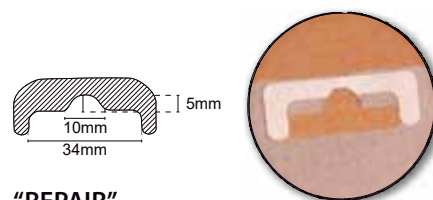

**"REPAIR"**

Ref: 12366    100x



## DIRECTORIO CON PERFIL "BEYELER"

Creado para ofrecer una señalización de rápida comprensión, fácil sustitución y ampliación modular, el sistema de señalización interior le ofrece los más altos standards de calidad.

Los sistemas gráficos totalmente personalizables, incluyen la posibilidad de impresión en inkjet como la rotulación en vinilo, aumentando así las posibilidades creativas a la hora de utilizar la señalización como elemento de decoración funcional y importancia en sus proyectos de interiorismo.

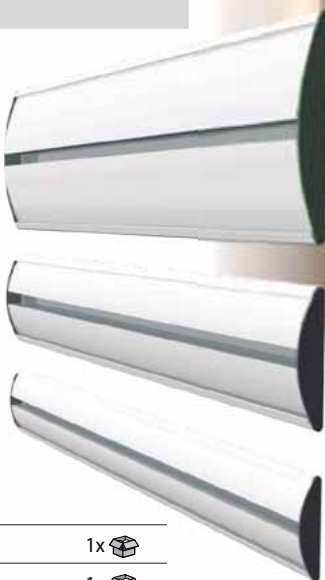

Ref: 10224	perfil alto 60mm	1x
Ref: 10225	perfil alto 90mm	1x
Ref: 10226	perfil alto 140mm	1x

## SISTEMA INFORMATIVO DE PLÁSTICO

Sistema informativo, compuesto de perfiles de plástico. Disponible en tres tamaños diferentes. Se suministran en kits completos. Uso interior en oficinas, centros comerciales, edificios públicos, etc. Fácil y rápido cambio de la gráfica. Gráfica no incluida.

Contenido: perfil de aluminio curvo, plásticos de fijación, placa de aluminio curvas y tapas laterales.

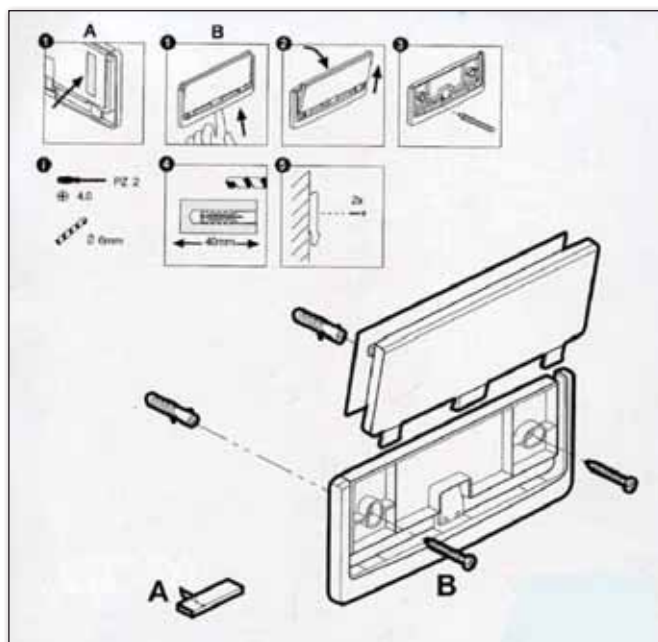

Ref: 15200	149x63mm		1x
Ref: 15201	149x104mm		1x
Ref: 15202	149x145mm		1x



## SISTEMA DE SEÑALIZACIÓN RECTO "BARGELLO"

Sistema de señalización de pictogramas e informativos de pared, compuesto de perfilería recta y placas de aluminio. Disponible en formato estándar de varios tamaños. Se suministran en kits completos. Uso interior en oficinas, centros comerciales, estaciones, aseos, etc. Fácil y rápido montaje mediante tornillos o adhesivo de doble cara. Materiales recomendados: vinilo de corte y vinilo de impresión. Gráficas y tornillería no incluidas.

Contenido: perfil de aluminio recto, plásticos de fijación, placa de aluminio y tapas laterales.

**Instalación:**

1. Realizar unos agujeros en los huecos ovalados que hay en las tapas laterales. (Este paso no se sigue si se va a fijar con cinta de doble cara.)
2. Atornillar a la pared las tapas, ajustándose a la anchura del perfil de aluminio. En el caso de la cinta de doble cara se pone en la parte trasera de las tapas y se coloca sobre la pared como lo dicho anteriormente.
3. Una vez sujetas las tapas a la pared, se coloca encima el perfil de aluminio presionando, hasta que quede sujeto.

### Pictogramas a pared

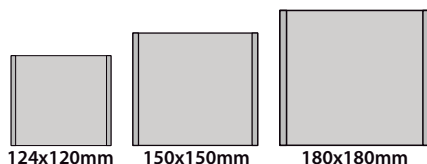
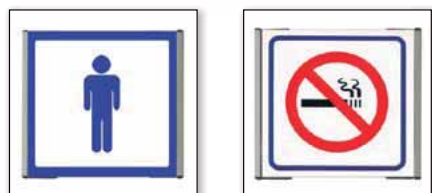
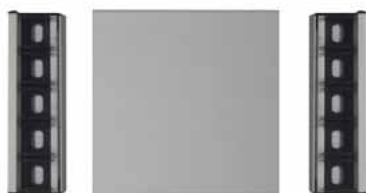

### Pictogramas de pared

Formatos estándar en varios tamaños. Los pictogramas se suministran en kit completos, totalmente montados y listos para su instalación. Gráficas y tornillería no incluidas.

Ref: 15668	124x120mm	1x
Ref: 15670	150x150mm	1x
Ref: 15672	180x180mm	1x

### Informativo recto estándar



### Informativo recto estándar

Sistema informativo recto estándar. Se suministran en kits completos. Gráficas y tornillería no incluidas.

Ref: 15634	60x120mm	1x	Ref: 15643	150x220mm	1x
Ref: 15635	60x220mm	1x	Ref: 15644	150x300mm	1x
Ref: 15636	60x300mm	1x	Ref: 15645	150x400mm	1x
Ref: 15637	90x150mm	1x	Ref: 15646	60x500mm	1x
Ref: 15638	90x220mm	1x	Ref: 15647	90x500mm	1x
Ref: 15639	90x300mm	1x	Ref: 15648	124x500mm	1x
Ref: 15640	124x150mm	1x	Ref: 15649	150x500mm	1x
Ref: 15641	124x220mm	1x	Ref: 15650	180x500mm	1x
Ref: 15642	124x300mm	1x			



## SISTEMA DE SEÑALIZACIÓN CURVO "ORSAY"

Sistema de señalización de pictogramas e informativos de pared, compuesto de perfilería curva y placas de aluminio. Disponible en formato estándar de varios tamaños. Se suministran en kits completos. Uso interior en oficinas, centros comerciales, estaciones, aseos, etc. Fácil y rápido montaje mediante tornillos o adhesivo de doble cara. Materiales recomendados: vinilo de corte y vinilo de impresión. Gráficas y tornillería no incluidas. Contenido: perfil de aluminio curvo, plásticos de fijación, placa de aluminio y tapas laterales.

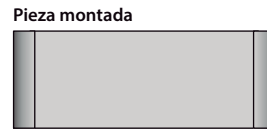
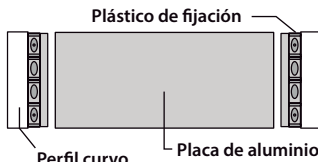
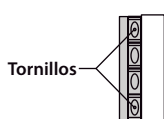
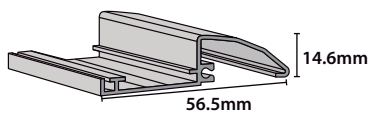

### Instalación:

1. Realizar unos agujeros en los huecos ovalados que hay en las tapas laterales. (Omitir si se va a fijar con cinta de doble cara.)
2. Atornillar a la pared las tapas, ajustándose a la anchura del perfil de aluminio. Si es cinta de doble cara, pegar a las tapas.
3. Una vez sujetas las tapas a la pared, se coloca encima el perfil de aluminio presionando, hasta que quede sujeto.

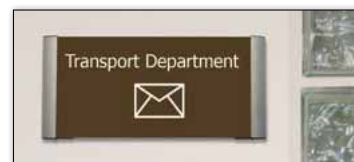

Ref: 15651	60x120mm	1x	
Ref: 15652	60x220mm	1x	
Ref: 15653	60x300mm	1x	
Ref: 15654	90x150mm	1x	
Ref: 15655	90x220mm	1x	
Ref: 15656	90x300mm	1x	

Ref: 15657	124x150mm	1x	
Ref: 15658	124x220mm	1x	
Ref: 15659	124x300mm	1x	
Ref: 15660	150x220mm	1x	
Ref: 15661	150x300mm	1x	
Ref: 15662	150x400mm	1x	

Ref: 15663	60x500mm	1x	
Ref: 15664	90x500mm	1x	
Ref: 15665	124x500mm	1x	
Ref: 15666	150x500mm	1x	
Ref: 15667	180x500mm	1x	

## SISTEMA DE SEÑALIZACIÓN "VICENZA"



Sistema informativo de pared, compuesto de perfilerías de aluminio para acoplar en conectores de plástico. Disponible en formato estándar de varios tamaños y colores. Uso interior en oficinas, centros comerciales, estaciones, aseos, etc. De fácil y rápido montaje mediante tornillos o adhesivo de doble cara. Gráficas y tornillería no incluidas. Posibilidad de mostrar dos mensajes mediante perfil con placa superior deslizante.

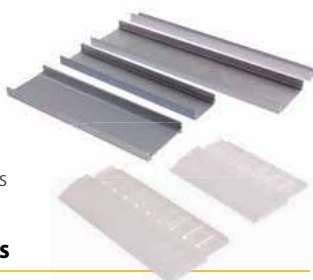
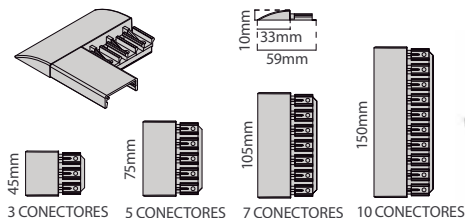

### Conectores

Ref: 15310	3 Conectores					10x	
Ref: 15311	5 Conectores					10x	
Ref: 15312	7 Conectores					10x	
Ref: 15313	10 Conectores					10x	

### Perfiles de aluminio

Ref: 15314	1 Conector	600mm		4x	
Ref: 15315	1 Conector	900mm		4x	
Ref: 15316	1 Conector	1400mm		4x	
Ref: 15317	2 Conectores	600mm		4x	
Ref: 15318	2 Conectores	900mm		4x	
Ref: 15319	2 Conectores	1400mm		4x	
Ref: 15320	3 Conectores	600mm		4x	
Ref: 15321	3 Conectores	900mm		4x	
Ref: 15322	3 Conectores	1400mm		4x	
Ref: 15323	3 Conectores Deslizante	600mm		4x	
Ref: 15324	3 Conectores Deslizante	900mm		4x	
Ref: 15325	3 Conectores Deslizante	1400mm		4x	



## SISTEMA DE SEÑALIZACIÓN ACRÍLICO

Sistema sencillo y versátil fabricado en acrílico. Montaje muy rápido y sencillo. Uso interior en oficinas, aseos, etc. Gráfica no incluida.



### Rectangular

Ref: 15207      195x60mm      1x



### Cuadrado

Ref: 15208      66x66mm      1x



\* Adhesivos incluidos

## SISTEMA SEÑALIZACIÓN CON LED

Sistema señalización interior con luz LED con embellecedores para la fijación de señalética a pared mediante piezas de aluminio retroiluminadas. Cristal o metacrilato no incluido.

Compuesto por: separador con LEDs blancos en su interior, convertidor de corriente y cable de conexión.



### Perfil para cristal sencillo

Ref: 15725	120mm	9 LEDs	4x
Ref: 15726	180mm	12 LEDs	1x
Ref: 15727	280mm	21 LEDs	1x

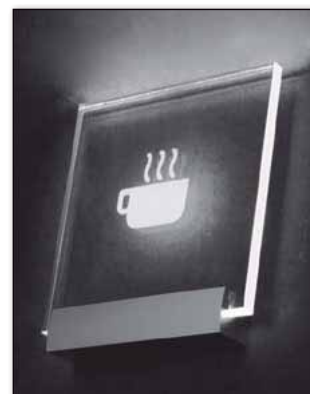

\* Cristal o acrílico no incluidos

## SISTEMA SEÑALIZACIÓN CON LED

Sistema señalización interior mediante embellecedores con luz LED para la fijación de señalética a pared mediante piezas de aluminio retroiluminadas. Cristal o metacrilato no incluido. Pack de 4 unidades.

Compuesto por: Separador - embellecedor con LEDs en aluminio satinado, convertidor de corriente y cable de conexión.



### Embellecedores LED

Ref: 15724      25x25mm      9 LEDs      4x



\* Pictogramas bajo pedido



\* Cristal o acrílico no incluidos

## SISTEMA DE BANDEROLAS A PARED "RECTO"

Sistema compuesto de placas de aluminio a doble cara para fijar a la pared. Disponibles en formato estándar de varios tamaños. Se suministran en kits completos. Uso interior en oficinas, centros comerciales, estaciones, aseos, etc. Fácil y rápido montaje mediante tornillos o adhesivo. Materiales recomendados: vinilo de corte y vinilo de impresión. Gráficas y tornillería no incluidas.

Contenido: Placas de aluminio de doble cara, soporte de fijación y tapas laterales.



Ref: 15685	90x220mm	1x
Ref: 15686	90x320mm	1x
Ref: 15687	124x220mm	1x

Ref: 15688	124x320mm	1x
Ref: 15689	124x420mm	1x
Ref: 15690	150x150mm	1x

Ref: 15691	150x220mm	1x
Ref: 15692	150x320mm	1x
Ref: 15693	150x420mm	1x

## SISTEMA DE SEÑALIZACIÓN ACRÍLICO

Sistema señalización interior compuesto por un "sandwich" de metacrilato de 3mm de espesor cada uno. Kits completos de uso interior. Fácil y rápido montaje. Gráficas y tornillería no incluidas. Magnético.

Contenido: piezas de anclaje a pared y 2 metacrilatos de 3mm.

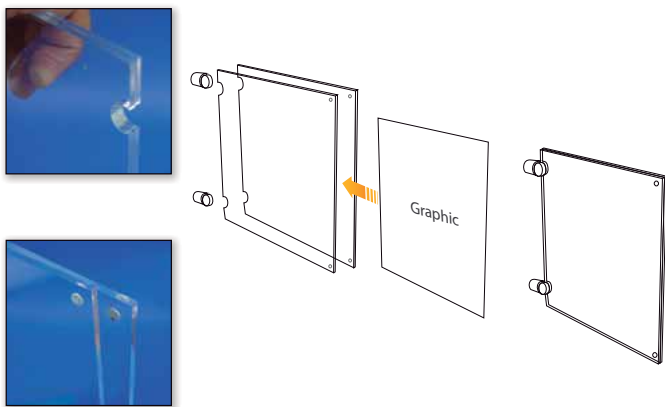

Ref: 15203	297x120mm		1x
Ref: 15204	120x297mm		1x
Ref: 15205	210x297mm		1x
Ref: 15206	210x210mm		1x





## SISTEMA DE SEÑALIZACIÓN DE PASILLO

Sistema compuesto de placas de Poliestireno a doble cara de 2mm de grosor para fijar a la pared. Están disponibles en formato estándar de varios tamaños. Uso interior en oficinas, centros comerciales, estaciones, aseos, etc. Fácil y rápido montaje mediante tornillos o adhesivo. Materiales recomendados: vinilo de corte y vinilo de impresión. Tornillería a pared no incluida.

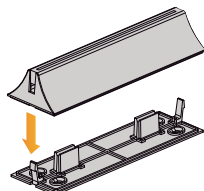
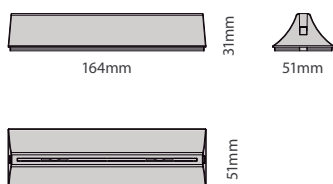
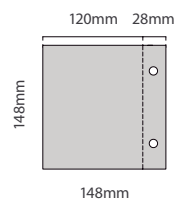
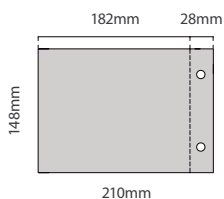
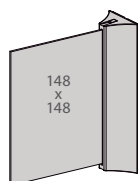
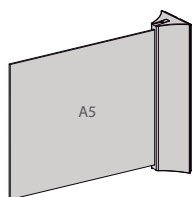
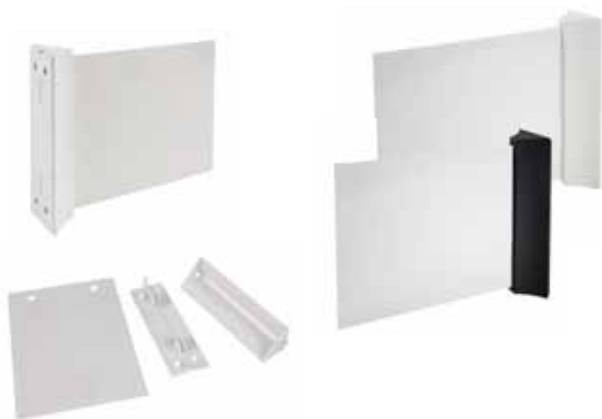
Posibilidad de impresión a doble cara de cualquier señal existente en el presente catálogo, bajo demanda.



### Soporte

Ref: 15326 164x51x31mm   5x 

### Señal impresa a doble cara (Área visible)

Ref: 15328 A5 (x2) Grosor: 2mm 5x 

Ref: 15330 148x148mm (x2) Grosor: 2mm 5x 

### Señal sin impresión (Área visible)

Ref: 15327 A5 Grosor: 2mm 5x 

Ref: 15329 148x148mm Grosor: 2mm 5x 

## SISTEMA DE SEÑALIZACIÓN

Sistemas de señalización a pared. No es necesario realizar taladro en el panel de gráfica. Permite el cambio de gráfica fácilmente.

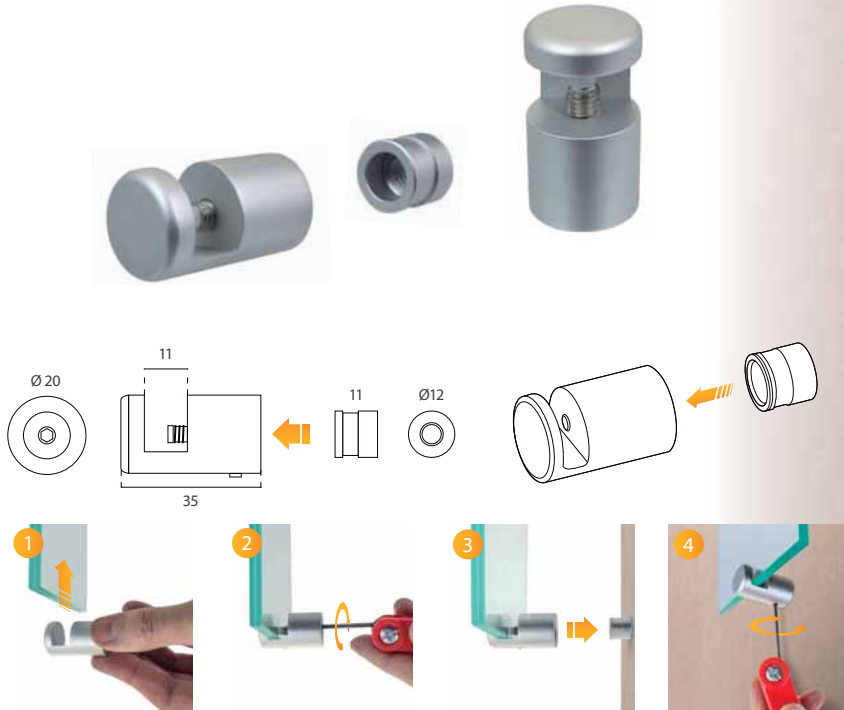

Ref: 15249 Grosor max. de panel 11mm Ø20x35mm 4x

5

## SISTEMA DE SOBREMESA CON SOPORTE

Sistema compuesto de 2 piezas de acero que permiten la colocación de un cartel sobre un escritorio a modo identificativo o informativo. Se suministran en bolsas de 2 unidades. Uso interior en escritorios, recepciones, mostradores, etc. Fácil y rápido montaje. Materiales recomendados: metacrilato, PS, placas de aluminio, etc. Placas y gráficas no incluidas.

Contenido: 2 piezas de acero cromado.



Ref: 15567	Ø8x80mm		2x
Ref: 15568	Ø8x80mm		2x
Ref: 15569	Ø8x80mm		2x
Ref: 15570	Ø8x80mm		2x



## SEPARADORES-EMBELLECEDORES

Sistema de fijación a pared de cartelería mediante dos piezas de acero que permiten aislarlo de la pared y a su vez proteger los tornillos utilizados para darle un mejor acabado. Disponible en color dorado y cromado en varias medidas. Se suministran packs de 4 unidades. Uso en interior y exterior, en placas de diferentes tipos, materiales y tamaños.

Contenido: separador y embellecedor.

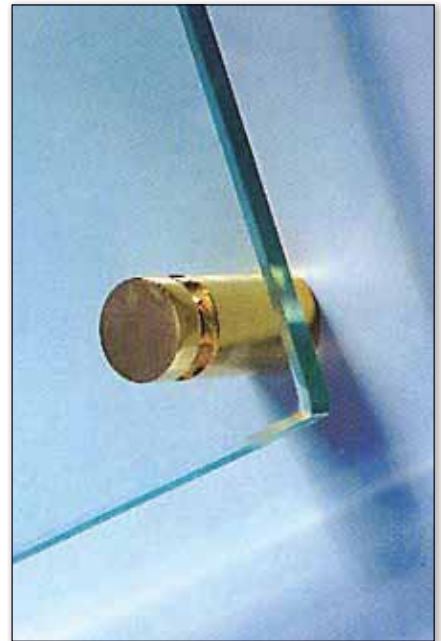



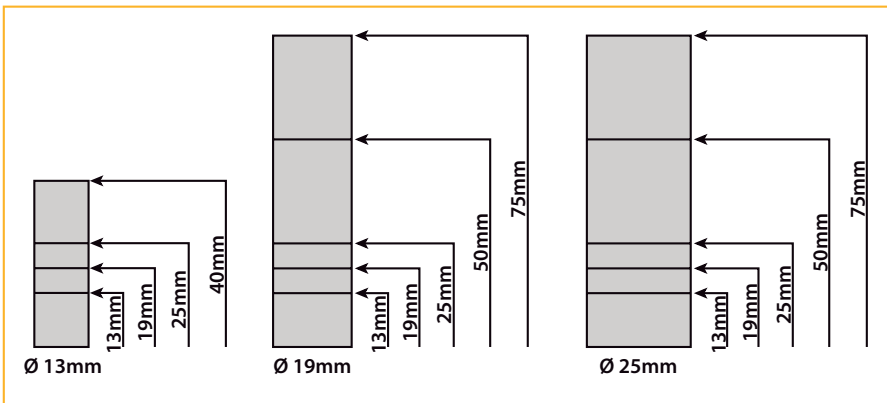



### Tamaños

























### Diámetro 13mm

	Ref: 15500	13x13mm		4x 
	Ref: 15501	13x19mm		4x 
	Ref: 15502	13x25mm		4x 
	Ref: 15503	13x40mm		4x 











	Ref: 15504	13x13mm		4x 
	Ref: 15505	13x19mm		4x 
	Ref: 15506	13x25mm		4x 
	Ref: 15507	13x40mm		4x 











### Diámetro 19mm

	Ref: 15508	19x13mm		4x 
	Ref: 15509	19x19mm		4x 
	Ref: 15510	19x25mm		4x 
	Ref: 15511	19x50mm		4x 
	Ref: 15512	19x75mm		4x 

	Ref: 15513	19x13mm		4x 
	Ref: 15514	19x19mm		4x 
	Ref: 15515	19x25mm		4x 
	Ref: 15516	19x50mm		4x 
	Ref: 15517	19x75mm		4x 

### Diámetro 25mm

	Ref: 15518	25x13mm		4x 
	Ref: 15519	25x19mm		4x 
	Ref: 15520	25x25mm		4x 
	Ref: 15521	25x50mm		4x 
	Ref: 15522	25x75mm		4x 

	Ref: 15523	25x13mm		4x 
	Ref: 15524	25x19mm		4x 
	Ref: 15525	25x25mm		4x 
	Ref: 15526	25x50mm		4x 
	Ref: 15527	25x75mm		4x 

## SEPARADORES-EMBELLECEDORES

Sistema de fijación a pared de cartelería mediante dos piezas de acero que permiten aislarlo de la pared y a su vez proteger los tornillos utilizados para darle un mejor acabado. Disponible en varios colores y medidas. Se suministran packs de 4 unidades. Uso en interior y exterior, en placas de diferentes tipos, materiales y tamaños.

Contenido: separador y embellecedor.



### Diámetro 13mm

Ref: 15528	13x13mm	■	4x
Ref: 15532	13x13mm	■	4x
Ref: 15536	13x13mm	■	4x
Ref: 15540	13x13mm	■	4x

Ref: 15529	13x19mm	■	4x
Ref: 15533	13x19mm	■	4x
Ref: 15537	13x19mm	■	4x
Ref: 15541	13x19mm	■	4x

### Diámetro 19mm

Ref: 15530	19x25mm	■	4x
Ref: 15534	19x25mm	■	4x
Ref: 15538	19x25mm	■	4x
Ref: 15542	19x25mm	■	4x

### Diámetro 25mm

Ref: 15531	25x30mm	■	4x
Ref: 15535	25x30mm	■	4x
Ref: 15539	25x30mm	■	4x
Ref: 15543	25x30mm	■	4x



## EMBELLECEDORES

Sistema que consiste en colocar unas anillas y embellecedores sobre las cabezas de los tornillos que quedan al descubierto para taparlos. Disponible en cromado y dorado. Se suministran packs de 4 unidades. Uso en interior y exterior, sobre placas de metacrilato u otros materiales a pared.

Contenido: separador y embellecedor.

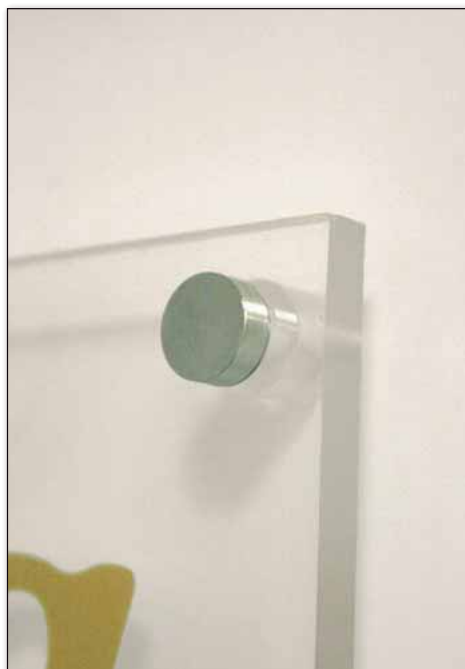

Ref: 15544	15mm	■	4x
Ref: 15545	19mm	■	4x
Ref: 15546	25mm	■	4x

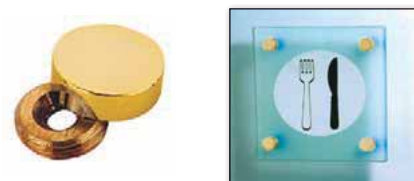





Ref: 15547	15mm	■	4x
Ref: 15548	19mm	■	4x
Ref: 15549	25mm	■	4x







## SEPARADOR

Sistema de separación de cartelería, que permite fijar en su interior materiales de 8 a 10mm de espesor. Disponible en dorado y cromado en varias medidas. Se suministran packs de 4 unidades. Uso en interior con metacrilatos, cristales, etc.

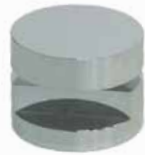
Contenido: 2 piezas (separadores).

Ref: 15550	20x25mm		4x 
Ref: 15551	20x30mm		4x 



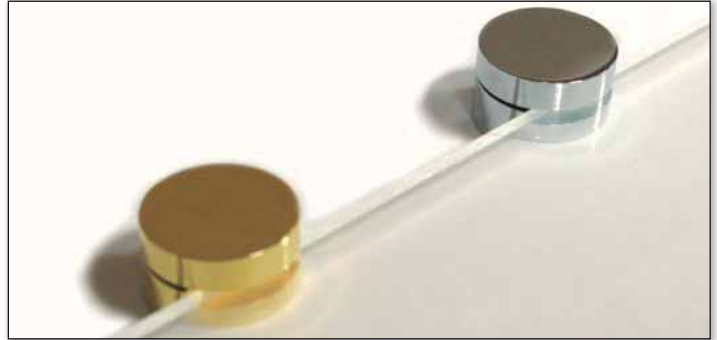
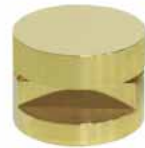

Ref: 15552	20x25mm		4x 
Ref: 15553	20x30mm		4x 



## SEPARADOR CUADRADO

Sistema de separación de cartelería, permite fijar en su interior materiales de hasta 10mm de espesor. Disponible en dorado y cromado. Se suministran packs de 4 unidades. Uso en interior con metacrilatos, cristales, etc.

Contenido: 2 piezas (separadores).

Ref: 15565	25x25mm		4x 
------------	---------	---	--



Ref: 15564	25x25mm		4x 
------------	---------	---	--

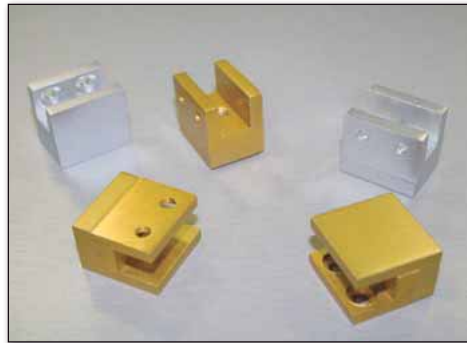

## SUJETA ESTANTES





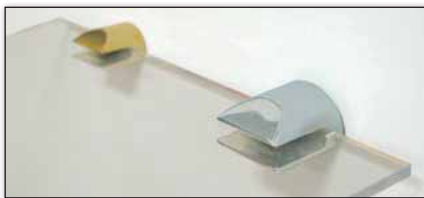



Sistema de sujeción de estanterías o cartelería mediante unas piezas de acero atornilladas a la pared. Disponible en dorado y cromado. Varios modelos a elegir. Uso para fijación de baldas en locales, tiendas, cartelería, etc.

Contenido: 1 pieza (sujeza estante).







Ref: 15558	35x35mm	Espesor 12mm		4x 
Ref: 15560	25x25mm	Espesor 9,5mm		4x 
Ref: 15559	35x35mm	Espesor 12mm		4x 
Ref: 15561	25x25mm	Espesor 9,5mm		4x 



Ref: 15554	30mm	Espesor 7,5mm		2x 
Ref: 15555	50mm	Espesor 9,5mm		2x 
Ref: 15556	30mm	Espesor 7,5mm		2x 
Ref: 15557	50mm	Espesor 9,5mm		2x 





Ref: 15562	80x25mm	Espesor 12mm		4x 
Ref: 15563	50x25mm	Espesor 10mm		4x 

# DISPENSADOR DE BOLSAS PARA PARAGUAS

## DISPENSADOR DE BOLSAS PARA PARAGUAS **NUEVO**

Mantenga limpio su establecimiento y evite accidentes por suelo resbaladizo. Ahorre en personal y productos de limpieza. Proteja sus productos e instalaciones del agua, proporcionando un espacio más confortable y limpio para clientes y trabajadores. Inserte el paraguas a través del orificio superior, una vez sólo quede fuera el mango, empuje de forma horizontal hacia afuera. En ese momento tendrá su paraguas dentro de la bolsa, protegido y listo para poder desplazarse por el establecimiento de forma cómoda, limpia y segura. Ideal para supermercados, centros comerciales, tiendas, museos y salas de exposiciones.



Ref: 81500	227x288x796mm	1x 
Ref: 81503	Bolsas grandes x100 Uni.	1x 

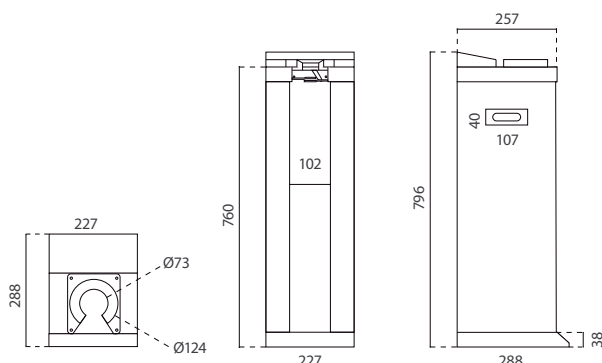



## DOBLE DISPENSADOR DE BOLSAS PARA PARAGUAS **NUEVO**

Mantenga limpio su establecimiento y evite accidentes por suelo resbaladizo. Ahorre en personal y productos de limpieza. Proteja sus productos e instalaciones del agua, proporcionando un espacio más confortable y limpio para clientes y trabajadores. Inserte el paraguas a través del orificio superior, una vez sólo quede fuera el mango, empuje de forma horizontal hacia afuera. En ese momento tendrá su paraguas dentro de la bolsa, protegido y listo para poder desplazarse por el establecimiento de forma cómoda, limpia y segura. Ideal para supermercados, centros comerciales, tiendas, museos y salas de exposiciones.

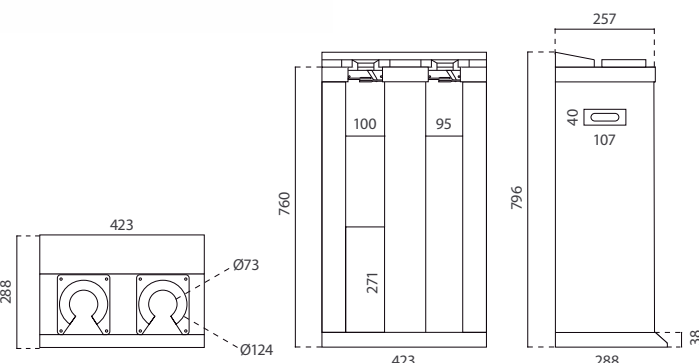

Ref: 81501	423x288x796mm	1x
Ref: 81502	Bolsas pequeñas x100 Uni.	1x
Ref: 81503	Bolsas grandes x100 Uni.	1x



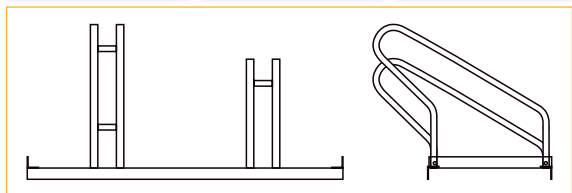

## APARCA BICICLETAS

Estructuras robustas diseñadas para poder ser unidas entre sí y también al suelo. Acabado galvanizado resistente al agua y a la corrosión.



Acabado en color gris  
Ral 9006.



Ref: 10705	700mm	2 plazas	1x 
Ref: 10706	1050mm	3 plazas	1x 
Ref: 10762	1750mm	5 plazas	1x 
Ref: 10782	2100mm	6 plazas	1x 
Ref: 10933	2450mm	7 plazas	1x 

## APARCA BICICLETA CON GRÁFICA A DOBLE CARA

Aparca bicicletas para 6 plazas galvanizado y pintado con pintura en polvo "Ral 9006". Gráficas tamaño A1 en marcos con sistema "click" a doble cara.



Ref: 10809	Gráfica tamaño A1	6 plazas	1x 
------------	-------------------	----------	--

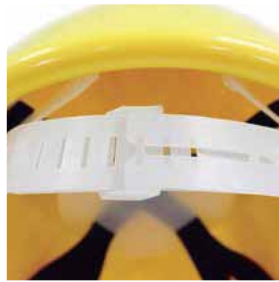

**eber**   
**Epis**  
 eberepis.com





## EQUIPO DE PROTECCIÓN INDIVIDUAL

---

En 1986 la Unión Europea, la Directiva 89/656/CEE del Consejo de Gobierno de 30-11-1989, establece las disposiciones mínimas de seguridad y de salud para la utilización por los trabajadores en el trabajo de equipos de protección individual. A los efectos de dicha Directiva se entiende por equipo de protección individual (EPI) cualquier equipo destinado a ser llevado o sujetado por el trabajador/a para que le proteja de uno o varios riesgos que puedan amenazar su seguridad o su salud en el trabajo, así como cualquier complemento o accesorio destinado a tal fin.

### MEDIDAS DE PROTECCIÓN INDIVIDUAL

---

Son equipos llevados por el trabajador para protegerle de los riesgos que puedan producir daños para su salud.

### NORMA GENERAL DE USO

---

Los equipos de protección individual deberán utilizarse cuando los riesgos no se puedan evitar o no puedan limitarse suficientemente por medios técnicos de protección colectiva o mediante medidas, métodos o procedimientos de organización del trabajo.

### OBLIGACIONES DE LOS EMPRESARIOS

---

1. Un equipo de protección individual debe adecuarse a las disposiciones comunitarias sobre diseño y construcción en materia de seguridad y de salud que lo afecten. En cualquier caso, un equipo de protección individual deberá:
  - A) Ser adecuado a los riesgos de los que haya que protegerse, sin suponer de por sí un riesgo adicional;
  - B) Responder a las condiciones existentes en el lugar de trabajo;
  - C) Tener en cuenta las exigencias ergonómicas y de salud del trabajador;
  - D) Adecuarse al portador, tras los necesarios ajustes.
2. En caso de riesgos múltiples que exijan que se lleven simultáneamente varios equipos de protección individual, dichos equipos deberán ser compatibles y mantener su eficacia en relación con el riesgo o los riesgos correspondientes.
3. Las condiciones en las que un equipo de protección individual deba utilizarse, en particular por lo que se refiere al tiempo durante el cual haya de llevarse, se determinarán en función de la gravedad del riesgo, de la frecuencia de la exposición al riesgo y de las características del puesto de trabajo de cada trabajador, así como de las prestaciones del equipo de protección individual.
4. Los equipos de protección individual estarán destinados, en principio, a un uso personal.
5. Si las circunstancias exigen la utilización de un equipo individual por varias personas, deberán tomarse medidas apropiadas para que dicha utilización no cause ningún problema de salud o de higiene a los diferentes usuarios.

CASCOS



**CASCO Industrial HDPE**

Norma: CE-EN 397:1995 + A1:2000  
Fabricado en polietileno de alta densidad.

Frontal para marcaje de logotipos.  
Barbuquejo elástico con mentonera.  
Anclajes universales para incorporar accesorios.  
Recoge aguas. Atalaje textil de 4 puntos de sujeción.  
Banda desudador de toalla recambiable de gran longitud, regulable, recubre el 70% del atalaje.  
Cierre corredera de plástico.

Ref: **80.901**



**x1** Unidad venta: 1 unidad  
28.5x22x15cm / 0.36kg

**x10** Packing: 10 unidades  
61x42x32cm / 4.6kg

**Packing: 30 unidades**  
72x54x43cm / 12kg



**CASCO Ingeniero ABS**

Norma: CE-EN 397:1995 + A1:2000  
Fabricado en ABS con aireación superior.

Diseño muy ergonómico.  
Frontal para marcaje de logotipos.  
Barbuquejo elástico con mentonera.  
Anclajes universales para incorporar accesorios.  
Recoge aguas. Atalaje textil de 6 puntos de sujeción.  
Cierre corredera de plástico de fácil ajuste *Fast Track*.  
Banda desudador de toalla recambiable de gran longitud.

Ref: **80.902**



**x1** Unidad venta: 1 unidad  
28.5x22x15cm / 0.36kg

**x10** Packing: 10 unidades  
61x41x32cm / 4.6kg

**Packing: 30 unidades**  
55x52x45cm / 12kg



## AURICULARES



**x1** Unidad venta: caja 1 uni.  
13x9x16cm / 0.33kg

**Packing:** 24 unidades  
50x27.5x39cm / 8kg

### AMORTIGUADOR de ruido adaptable para casco

Norma: CE-EN 352-3:2002  
Interior almohadillado de gran comodidad.  
Con adaptador universal. SNR: 29 dB

Ref: **80.916**

1x



**x1** Unidad venta: bolsa 1 uni.  
19x8x18cm / 0.14kg

**Packing:** 50 unidades  
66x37x37cm / 8kg

### AMORTIGUADOR de ruido diadema

Norma: CE-EN 352-1:2003  
Fabricado en ABS.  
Interior almohadillado de gran comodidad.  
Posibilidad de usarlo con o sin casco. La diadema puede ajustarse en la nuca para la utilización simultanea del amortiguador con un casco de protección.  
SNR: 27 dB

Ref: **80.917**

1x



**x1** Unidad venta: caja 1 uni.  
16x9x19cm / 0.34kg

**Packing:** 24 unidades  
59x33x42cm / 8kg

### AMORTIGUADOR de ruido diadema

Norma: CE-EN 352-1:2002  
Fabricado en ABS.  
Banda e interior almohadillado de gran confort.  
Forma ergonómica para un ajuste perfecto.  
SNR: 29 dB

Ref: **80.915**

1x





**AURICULARES**



**x1** Unidad venta: caja 1 uni. 15x10x13cm / 0.285kg **Packing:** 20 unidades 51x31x28cm / 8kg

**AMORTIGUADOR de ruido diadema plegable**

Norma: CE-EN 352-1:2002  
 Fabricado en ABS y con sujeciones de acero inoxidable.  
 Sistema de plegado con brazos telescópicos.  
 Interior almohadillado de gran comodidad.  
 SNR: 27 dB

Ref: **80.918** 1x



**x1** Unidad venta: caja 1 uni. 18x9x19cm / 0.365kg **Packing:** 20 unidades 50x37x40cm / 9.5kg

**AMORTIGUADOR de ruido diadema**

Norma: CE-EN 352-1:2002  
 Fabricado en ABS y con sujeciones de acero inoxidable.  
 Incorpora nueva tecnología de doble carcasa que minimiza la resonancia y favorece una mejor comprensión del habla.  
 Con anillos de sellado anchos y rellenos con espuma blanda para mejorar la presión y el contacto del auricular.  
 Apto para lugares con exposición a altos niveles de ruido.  
 SNR: 35 dB

Ref: **80.919** 1x



## TAPONES



Unidad venta: caja 200 pares  
20x12.7x19.5cm / 0.43kg



Packing: 4000 pares  
66x42x42cm / 10kg

## TAPONES Desechables de poliuretano

Norma: CE-EN 352-2:2002  
Fabricado en espuma de poliuretano.  
Color amarillo para resaltar visiblemente su colocación.  
Par en bolsa.  
SNR: 35 dB

Ref: **80.923**

200x



Unidad venta: caja 100 pares  
20x12.7x19.5cm / 0.39kg



Packing: 2000 pares  
66x42x42cm / 9.5kg

## TAPONES Desechables de poliuretano con cordón

Norma: CE-EN 352-2:2002  
Fabricado en espuma de poliuretano.  
Cordón de seguridad azul muy apropiado para la industria alimentaria por su rápida localización en caso de pérdida, ya que es el único color que no existe como alimento. Par en bolsa.  
SNR: 35 dB

Ref: **80.924**

100x



Unidad venta: caja 200 pares  
33.5x16x7.5cm / 0.42kg



Packing: 4000 pares  
66x34.5x46cm / 9.5kg

## TAPONES Reutilizable de silicona

Norma: CE-EN 352-2:2002  
Fabricado en espuma de silicona color azul muy apropiado para la industria alimentaria por su rápida localización en caso de pérdida, ya que es el único color que no existe como alimento. Par en bolsa.  
SNR: 30 dB

Ref: **80.925**

200x



Unidad venta: caja 100 pares  
33.5x16x7.5cm / 0.33kg



Packing: 2000 pares  
66x34.5x46cm / 7.5kg

## TAPONES Reutilizable de silicona con cordón

Norma: CE-EN 352-2:2002  
Fabricado en espuma de silicona color azul con cordón azul muy apropiado para la industria alimentaria por su rápida localización en caso de pérdida, ya que es el único color que no existe como alimento. Par en bolsa.  
SNR: 30 dB

Ref: **80.926**

100x

## GAFAS



**x1** Unidad venta: caja 10 uni. 33.5x16x7.5cm / 0.55kg **Packing:** 200 unidades 66x34.5x46cm / 12kg

### Gafa Tipo visita

Norma: CE-EN 166 1FT  
 Visor fabricado en policarbonato incoloro. Protección UV.  
 Posibilidad de utilizar como cubregafa. Protección contra impactos de baja energía. Diseño clásico y funcional con gran adaptación sobre la zona ocular.

Ref: **80.933** 10x



**x1** Unidad venta: bolsa 10 uni. 41x21x9cm / 0.85kg **Packing:** 200 unidades 76x41x45cm / 20kg

### Gafa Antipolvo integral

Norma: CE-HKN 1 B EN 166 B  
 Montura integral con 4 válvulas de ventilación para evitar la entrada de pequeñas partículas de polvo y contra impactos de media energía. Posibilidad de utilizar como cubregafa. Visor incoloro de policarbonato. Cinta elástica regulable.

Ref: **80.935** 10x





## GAFAS



## Gafa Industrial HDPE

Norma: CE-EN 166 1FT  
 Visor fabricado en policarbonato con protección UV.  
 Diseño clásico y muy ergonómico para proporcionar confort.  
 Gran adaptación en la zona ocular para no permitir la entrada de partículas. Protección contra impactos de baja energía.  
 Patilla regulable.

Colores:

- Montura azul, visor incoloro 80934-1
- Montura negra, visor amarillo 80934-2
- Montura azul, visor negro 80934-3

Ref: **80.934**

10x



x1

Unidad venta: caja 10 uni.  
 33.5x16x7cm / 0.50kg



Packing: 200 uds  
 66x34.5x39cm / 11kg



## Gafa PC Montura negra visor incoloro

Norma: CE-EN 166 1F  
 Gafas de seguridad con lentes de PC antiarañazos, resiste a impactos y con protección UV. Las patillas son extensibles, con 4 niveles de ajuste. La lente es fácilmente reemplazable.

Ref: **80.936**

10x



x1

Unidad venta: caja 10 uni.  
 16x10x31cm / 0.425kg



Packing: 200 uni.  
 51x34x64cm / 10kg

## MASCARILLAS



**x1** Unidad venta: caja 20 uni.  
14x13x18.5cm / 0.30kg

**Packing:** 400 unidades  
66x28.5x38cm / 8kg

### MASCARILLA Celulosa de polvo FFP1

Norma: CE-EN 149:2001+A1:2009  
FFP1: Protección frente a polvo y nieblas de baja toxicidad. De forma esférica para una óptima adaptación. Cuenta con clip nasal y con doble goma de ajuste amarilla. Indicadas para trabajos al aire libre.

Filtra hasta 4 veces el TLV.

Ref: **80.943**

20x



**x1** Unidad venta: caja 20 uni.  
14x13x28.5cm / 0.40kg

**Packing:** 200 unidades  
66x30x30cm / 5kg

### MASCARILLA Celulosa de polvo con válvula FFP2

Norma: CE-EN 149:2001+A1:2009  
FFP2: Protección contra partículas sólidas y líquidas de media toxicidad. Válvula de exhalación para evitar calor y humedad dentro de la mascarilla. Forma esférica para una óptima adaptación. Clip nasal y doble goma de ajuste.

Filtra hasta 12 veces el TLV.

Ref: **80.944**

20x



**x1** Unidad venta: caja 10 uds  
17.5x13x19cm / 0.3kg

**Packing:** 100 uds  
66x37.5x32cm / 4kg

### MASCARILLA Celulosa de polvo con válvula FFP3

Norma: CE-EN 149:2001+A1:2009  
FFP3: Alta protección contra aerosoles sólidos y líquidos tóxicos para concentraciones de hasta 50 veces el VME. Válvula de exhalación para evitar calor y humedad dentro de la mascarilla. Forma esférica para una óptima adaptación. Cuenta con clip nasal y con doble goma de ajuste.

Filtra hasta 50 veces el TLV.

Ref: **80.945**

10x



## LAVAJOS



### LAVAJOS PARA ENCASTRAR

Lavaojos para colocación sobre encimera, fabricado en acero inoxidable y provisto con regulación de presión manual.

Ref: **80.971**

1x

### LAVAJOS A PARED

Lavaojos para colocación a pared, está fabricado en acero inoxidable y provisto con pulsador de mano.

Ref: **80.976**

1x



### LAVAJOS CON PIE

Lavaojos fabricado en acero inoxidable, con o sin pedal.

Ref: **80.972**

930x0300mm

1x

Ref: **80.974**

Con Pedal

980x0300mm

1x





## LAVAJOS



### LAVAJOS CON DUCHA

Lavaojos con ducha en acero inoxidable, con o sin pedal.

Ref: <b>80.973</b>	2300x640mm	1x
Ref: <b>80.975</b> Con Pedal	2300x640mm	1x